

SILCA NEWS

ALL THE NEW KEYS, AUTOMOTIVE SOLUTIONS, KEY CUTTING MACHINES, SOFTWARE UPDATES AND MUCH MORE

2024
JUNE

NR.
06

QUATTROCODE *D700*











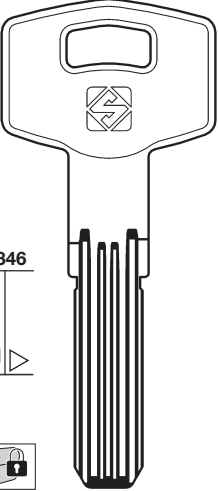

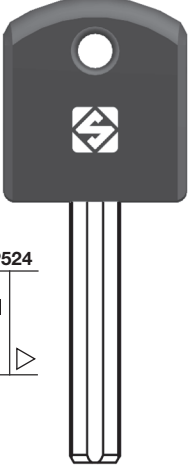

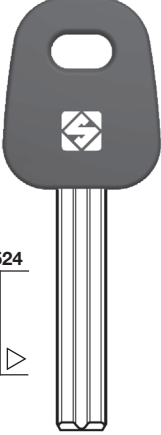
NETWORK WITH US

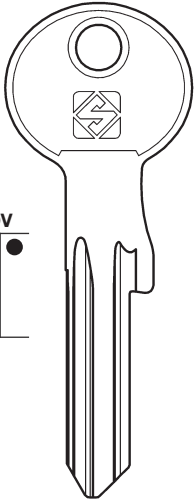

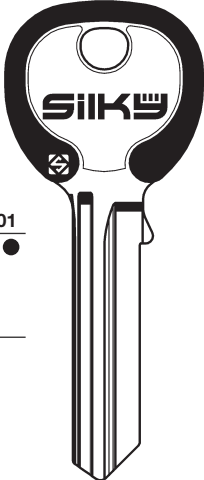

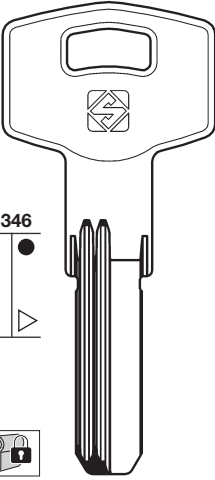



Silca key blanks are compatible with third party manufacturers' cylinders specified here below:

AMIG*	AXA*		
 <p>1346</p>  <p>AMG7</p>  <p>8 052782 045924</p> <p>Box of 50</p>	 <p>P524</p>  <p>AX16FP</p>  <p>8 052782 045696</p> <p>Box of 25</p>	 <p>P524</p>  <p>AX17EP</p>  <p>8 052782 046501</p> <p>Box of 25</p>	<p>AMIG*^(ES)</p> <p>AXA*^(NL)</p> <p>ISEO*^(IT)</p> <p>LOCKWOOD*^(AU)</p> <p>NOORI*^(BA)</p>
ISEO*	LOCKWOOD*	NOORI*	<p>(*) This is a trademark of a third party not affiliated nor linked with Silca S.p.A. or the dormakaba Group. Silca S.p.A. and dormakaba Group do not own any intellectual property right nor have been granted any license with regard to such trademark, which is hereby used only to indicate the intended purpose of Silca's products.</p>
 <p>OV</p>  <p>IE40</p>  <p>8 052782 046129</p> <p>Box of 50</p>	 <p>1601</p>  <p>LW5DZ</p> 	 <p>1346</p>  <p>NOR1R</p>  <p>8 052782 046402</p> <p>Box of 50</p>	

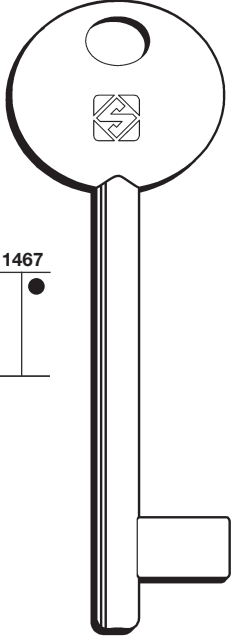

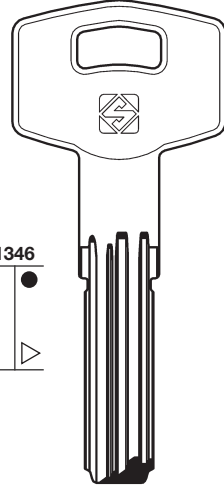
Silca key blanks are compatible with third party manufacturers' cylinders specified here below:

PATENT	STS*	
 <p>1467</p>  <p>6P11MP</p>  <p>8 052782 044286 Box of 25</p>	 <p>1346</p>  <p>STS15</p>  <p>8 052782 046778 Box of 50</p>	<p>PATENT</p> <hr/> <p>STS* (ES)</p> <hr/> <p>(*) This is a trademark of a third party not affiliated nor linked with Silca S.p.A. or the dormakaba Group. Silca S.p.A. and dormakaba Group do not own any intellectual property right nor have been granted any license with regard to such trademark, which is hereby used only to indicate the intended purpose of Silca's products.</p>



UPDATE YOUR SMART PRO NOW!

Data update with new vehicle applications / Aggiornamento dati con nuove applicazioni veicolo / Datenaktualisierung mit neuen Fahrzeug-Anwendungen / Mise à jour des données avec des nouvelles applications de véhicules / Actualización de datos con nuevas aplicaciones de vehículos / Atualização de dados com novas aplicações de veículos

Silca Advanced Diagnostics software to program car keys compatible with third party makes and models specified below:

REGION	MAKE*	MODEL*	YEAR START	YEAR END	KEY TYPE	SW MODULE
Europe	Jeep	Compass	2019	2022	BLADE	ADS2295
Europe	Peugeot	2008	2019	2024	BLADE	ADS2188
Europe	Peugeot	2008	2021	2024	PROX	ADS2188
Europe	Lexus	GS300h	2015	2018	PROX	ADS2328
Europe	Toyota	Prius	2015	2018	PROX	ADS2150
Europe	Suzuki	S-Cross SX4	2021	2024	PROX	ADS2233
Europe	Fiat	Doblo	2022	2024	BLADE	ADS2142
Europe	Maserati	Quattroporte	2014	2016	PROX	ADS2178
Asia	Citroën	C3 Aircross	2017	2022	PROX	ADS2188
Asia	Peugeot	106	1997	2004	BLADE	ADS2105
Asia	Alfa Romeo	159	2007	2011	SLOT	ADS2168
Australia	Ford	F150	2004	2008	BLADE	ADS2100
Australia	Ford	F150	2009	2010	BLADE	ADS2100
Australia	Ford	F150	2011	2014	BLADE	ADS2175
Australia	Ford	F150	2015	2017	PROX	ADS2209
Australia	Ford	F150	2015	2020	BLADE	ADS2209
Australia	Ford	F150	2018	2020	PROX	ADS2269
Australia	Ford	F250 SD	2000	2007	BLADE	ADS2100
Australia	Ford	F250 SD	2008	2010	BLADE	ADS2100
Australia	Ford	F250 SD	2011	2016	BLADE	ADS2100
Australia	Ford	F250 SD	2015	2019	BLADE	ADS2209
Australia	Ford	F250 SD	2017	2017	PROX	ADS2209
Australia	Ford	F250 SD	2018	2019	PROX	ADS2269
Australia	Ford	F250 SD	2020	2022	BLADE	ADS2269

(*) This is a trademark of a third party not affiliated nor linked with Silca S.p.A. or the dormakaba Group. Silca S.p.A. and dormakaba Group do not own any intellectual property right nor have been granted any license with regard to such trademark, which is hereby used only to indicate the intended purpose of Silca's products.

> More info at mykeyspro.com



UPDATE YOUR SMART PRO NOW!

FREE Update

REGION	MAKE*	MODEL*	YEAR START	YEAR END	KEY TYPE	SW MODULE
Australia	Ford	F250 SD	2020	2022	PROX	AADS2269
Australia	Ford	F350 SD	2009	2010	BLADE	ADS2100
Australia	Ford	F350 SD	2009	2010	BLADE	ADS2100
Australia	Ford	F350 SD	2011	2016	BLADE	ADS2175
Australia	Ford	F350 SD	2017	2019	PROX	ADS2209
Australia	Ford	F350 SD	2020	2022	BLADE	ADS2269
Australia	Ford	F350 SD	2020	2022	PROX	ADS2269
Australia	Fiat	Ducato	2015	2021	BLADE	ADS2327
Australia	Toyota	Alphard	2020	2024	PROX	ADS2150
Australia	Nissan	Serena	2016	2024	PROX	ADS2159
Canada	Hyundai	Santa Fe	2024	2024	PROX	ADS2321
Canada	Hyundai	Kona	2024	2024	PROX	ADS2321
New Zealand	Ford	Mondeo	2014	2018	PROX	ADS2209
New Zealand	Nissan	Serena	2016	2024	PROX	ADS2159
USA	Lexus	GS300	1997	2004	BLADE	ADS2125
USA	Lexus	GS400	1998	2001	BLADE	ADS2125
USA	Lexus	GS430	1998	2000	BLADE	ADS2125

SET SMART PRO DIRECTLY FROM MYKEYS PRO



MYKEYS Pro

mykeyspro.com



(*) This is a trademark of a third party not affiliated nor linked with Silca S.p.A. or the dormakaba Group. Silca S.p.A. and dormakaba Group do not own any intellectual property right nor have been granted any license with regard to such trademark, which is hereby used only to indicate the intended purpose of Silca's products.

> More info at mykeyspro.com

NEW VEHICLE KEY PROGRAMMING VIDEOS FOR MYKEYS PRO PREMIUM SUBSCRIBERS

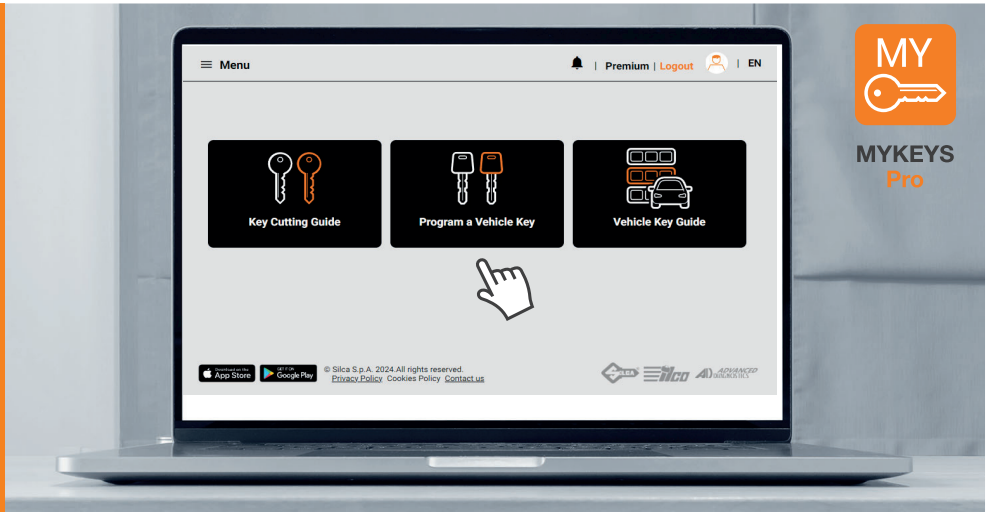

Program a Vehicle Key

Search by Make (1)

- AUDI
- A3
- Model Code (Chassis) [Generation]
- EUROPE
- 2018

Search by Make or Model

AUDI

AUDI A3 2015 - 2018

Chassis : MQB
Fuel : ANY
Key Type : BLADE
Region : EUROPE

NEW SMART PRO PROGRAMMING VIDEOS ON MYKEYS PRO PREMIUM

- Audi* A3 - 2018
- Citroën* C3 - 2018
- Nissan* Micra - 2019
- Opel* Combo - 2019
- Smart* Fortwo - 2014

...and many more to come!

Additional Information

- Vehicle Photo
- SmartPro Key Programming Video
- Diagnostic Socket Location (RHD)
- Chassis Plate Location

www.mykeyspro.com

(*) This is a trademark of a third party not affiliated nor linked with Silca S.p.A. or the dormakaba Group. Silca S.p.A. and dormakaba Group do not own any intellectual property right nor have been granted any license with regard to such trademark, which is hereby used only to indicate the intended purpose of Silca's products.



NEW

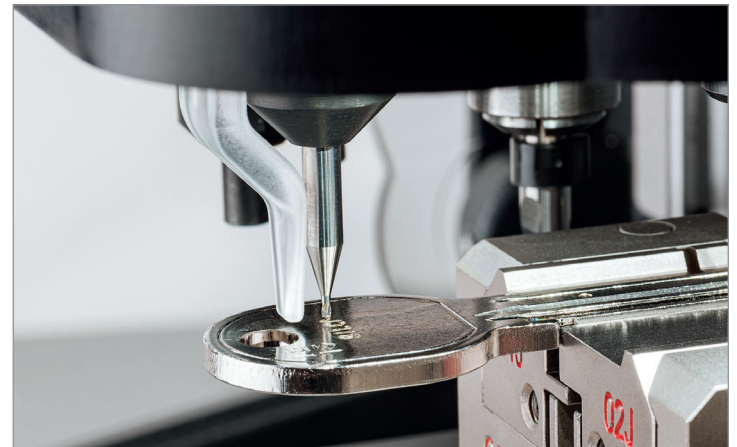

QUATTROCODE *D700*

NEW

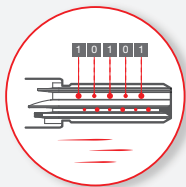

20% faster

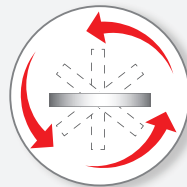

4-sided key rotation

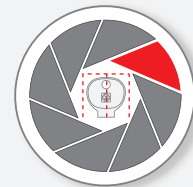

Video camera



0 key set-up time

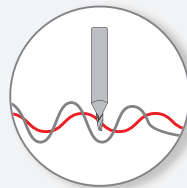

RFID cutter detection

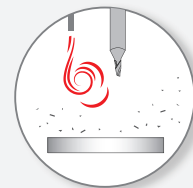

Compressed air

CUTS AND ENGRAVES DIMPLE AND LASER KEYS IN ONE SINGLE PROCESS

The Silca Quattrocode D700 cuts and engraves dimple and laser keys in one single process to improve the speed and quality of service to your customer. Thanks to the robot arm, which turns and positions the key automatically, keys are cut and engraved without needing to be manually re-positioned.

Silca Quattrocode D700 taglia e incide chiavi punzonate e laser in un unico processo per migliorare la velocità e la qualità del servizio al cliente. Grazie al braccio robot, che gira e posiziona automaticamente la chiave, le chiavi vengono tagliate e incise senza bisogno di essere riposizionate manualmente.

Silca Quattrocode D700 sie fräst und graviert Bahnen- und Bohrmulden-schlüsseln in einem einzigen Arbeitsgang, um die Geschwindigkeit und die Qualität der Dienstleistungen für Ihre Kunden zu verbessern. Dank des Roboterarms, der den Schlüssel automatisch dreht und positioniert, werden die Schlüssel gefräst und graviert, ohne dass sie manuell neu positioniert werden müssen.

Silca Quattrocode D700 taille et grave les clés à points et au laser en un seul processus pour améliorer la rapidité et la qualité du service rendu à votre client. Grâce au bras robotique qui tourne et positionne automatiquement la clé, les clés sont taillées et gravées sans avoir besoin d'être repositionnées manuellement entre chaque opération.

Silca Quattrocode D700 corta y graba llaves de regata y de seguridad en un solo proceso para mejorar la velocidad y la calidad del servicio a su cliente. Gracias al brazo robótico, que gira y posiciona la llave automáticamente, las llaves se cortan y graban sin necesidad de repositionarlas manualmente.

Silca Quattrocode D700 corta e grava chaves de pontos e laser num procedimento único para melhorar a rapidez e a qualidade do serviço. As chaves são cortadas e gravadas sem a necessidade de reposicionamento manual, devido ao braço robótico que gira e posiciona a chave automaticamente.



QUATTROCODE D700

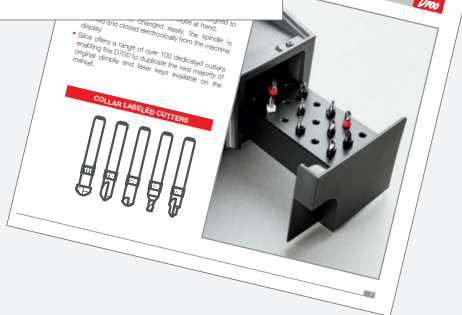

Visit Quattrocode D700



SILCA WEBSITE



MYKEYS PRO



SILCA YOU TUBE

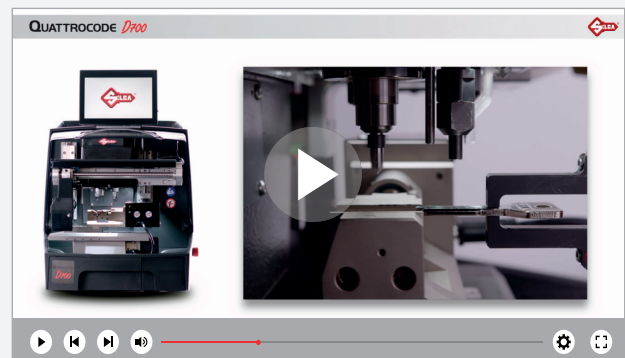

Emulator Cable suitable for Ford* ADC2020 - Code D756922AD



Enables faster programming of replacement Ford proximity and bladed keys even when the alarm is active and no working key is available.

Cavo Emulatore compatibile con Ford

Consente una programmazione più rapida delle chiavi Ford sostitutive quando l'allarme è attivo e anche in assenza totale di chiavi.

Schlüssel-Emulator Kabel kompatibel mit Ford

Ermöglicht eine schnellere Programmierung von Ford Ersatzschlüsseln, auch wenn der Alarm aktiv ist und kein funktionierender Schlüssel verfügbar ist.

Câble émulateur compatible avec Ford

Permet une programmation plus rapide des clés de proximité et des clés à lame Ford de remplacement, même lorsque l'alarme est activée et qu'aucune clé fonctionnelle n'est disponible.

Cabo Emulador compatível com Ford

Permite uma programação mais rápida de chaves de proximidade e chaves de metal de substituição Ford, mesmo quando o alarme está ativo e nenhuma chave funcional está disponível.

Cable emulador para Ford

Reduzca el tiempo de programación de las llaves de Ford, tanto para modelos con proximidad y sin proximidad, en caso de pérdida total de llaves e incluso cuando la alarma esté activada.



What else is needed?



Smart Pro



ADS2269
Programming Software



HU101R15



HU101AP05

Applications

Make*	Model	Variant	Key Type	From	To	Trp ID	Silca Key Ref.
Ford	Edge		Proximity	2015	2017		
Ford	Endura	(CA) [GEN1]	Proximity	2018	2024		
Ford	Everest	UA	Proximity	2015	2022		
Ford	F-150		Proximity	2018	2020		
Ford	Galaxy	CD390 [GEN 3]	Proximity	2015	2017	ID47	HU101AP05
Ford	Galaxy	CD390 [GEN 3 FL]	Proximity	2017	2019	ID47	HU101AP05
Ford	Mondeo	CD391 (LVSHF)	Proximity	2014	2024	ID47	HU101AP05
Ford	Mondeo Vignale	Vignale	Proximity	2014	2024	ID47	HU101AP05
Ford	Mustang	S550	Proximity	2015	2024	ID47	HU101AP05
Ford	Ranger	P375 (6FPPX)	Bladed	2016	2019	ID47	HU101R15
Ford	Ranger	(PX MKIII)	Proximity	2018	2022		
Ford	Transit		Bladed	2017	2019	ID47	HU101R15

> More info at mykeyspro.com





* This is a trademark of a third party not affiliated nor linked with Silca S.p.A. or the dormakaba Group. Silca S.p.A. and dormakaba Group do not own any intellectual property right nor have been granted any license with regard to such trademark, which is hereby used only to indicate the intended purpose of Silca's products.









SKP PRO 1/2024 for Web Subscribers

New cutting cards and series / Nuove schede e serie / Neue Karten und Serien / Nouvelles fiches et séries / Nuevas fichas y series / Novas fichas e séries

SKP PRO 1/2024 - v. 31.7.0.x - Web Update

QCD/TRIAX PROGRAM	
Lock Manufacturer*	System*
AMIG 	Amig 9645 (6+6+5)
ERREBI	LOK 2000 (5+4)
EVVA 	DPI (Lateral cut)
EVVA 	EPS (Lateral cut)
HUF	VW HU66P (2T-8W)
HUF	VW HU66P (2T-8W)
KIA	Kia (2T-8W)
LINKE	LINKE (6P) sx
MOIA	MCHGYPC (7+4+3) new
MOIA	MCHGYPC/C (6+4+3) new
MOIA	MCHGYPC/CP01 (7+4+4)
MOIA	MCHGYPC/M (7+4+3) new
OMEC 	OMEC OTTO
SISO	SISO (2T-5W)

CODE PROGRAM	
Lock Manufacturer*	System*
AUSTRALIAN LOCK	Binary Plus Master
CES 	CES PSM
CES 	CES PSM
CES 	CES PSM
CES 	CES UDM
CES 	CES UDM
CES 	CES UDM
PIAGGIO	Porter (8P)

KEY READER PROGRAM

Update with **261** new references / Aggiornamento con **261** nuove referenze / Aktualisierung mit **261** neuen Referenzen / Mise à jour avec **261** nouvelles références / Actualización con **261** nuevas referencias / Atualização com **261** novas referências

(*) This is a trademark of a third party not affiliated nor linked with Silca S.p.A. or the dormakaba Group. Silca S.p.A. and dormakaba Group do not own any intellectual property right nor have been granted any license with regard to such trademark, which is hereby used only to indicate the intended purpose of Silca's products.

> More info on [all Silca websites](#)



LEGAL NOTES

In compliance with current regulations relating to industrial property, please note that - but for "Silca", "dormakaba", "Kaba", "Ilco" and "Advanced Diagnostics" - the trademarks or trade names mentioned in our document are the exclusive property of third parties not affiliated nor linked with Silca S.p.A. or the dormakaba Group. Silca S.p.A. and dormakaba Group do not own any intellectual property right nor have been granted any license with regard to such trademarks and trade names, which are hereby used only to indicate the intended purpose of Silca's products. / This catalogue is reserved exclusively for professional key cutters who use Silca products. The illustrations and technical data regarding the products in the document are to be considered indicative. Silca reserves the right to alter products designs, dimensions or info to improve the products quality. The contents of this document are fully protected by Copyright and may not be copied or reproduced in any form, without written permission from Silca S.p.A. For any dispute the competent Court is that of Treviso, the applicable law is that of Italy.

RECHTLICHE HINWEISE

In Übereinstimmung mit den geltenden Bestimmungen zum gewerblichen Eigentum weisen wir darauf hin, dass - mit Ausnahme von "Silca", "dormakaba", "Kaba", "Ilco" und "Advanced Diagnostics" - die in unserem Dokument erwähnten Markenzeichen oder Handelsnamen das ausschließliche Eigentum Dritter sind, die weder der Silca S.p.A. noch der dormakaba Gruppe angehören oder mit diesen verbunden sind. Diese Markenzeichen oder Handelsbezeichnungen werden hier nur erwähnt, um auf die bestimmungsgemäße Verwendung der Silca-Produkte hinzuweisen. / Dieser Katalog ist ausschließlich professionellen Schlüsseldiensten vorbehalten, die Silca-Produkte verwenden. Die in diesem Dokument enthaltenen Abbildungen und technischen Daten der Produkte sind als Richtwerte zu betrachten. Silca behält sich vor, etwaige Änderungen, die zur Verbesserung des Produktes beitragen, vorzunehmen. Alle Zeichnungen und Fotos sind Eigentum der Firma Silca. Jede Reproduktion, auch teilweise, ist ohne ausdrückliche Genehmigung der Silca S.p.A. gesetzlich untersagt. Für alle Streitigkeiten ist das Gericht von Treviso zuständig, das geltende Recht ist italienisch.

AVISOS LEGALES

En cumplimiento de la normativa vigente en materia de propiedad industrial, se recuerda que, salvo para "Silca", "dormakaba", "Kaba", "Ilco" y "Advanced Diagnostics", las marcas y los nombres comerciales citados en nuestro documento son propiedad exclusiva de terceras sociedades, no afiliadas ni asociadas con Silca S.p.A. o el Grupo dormakaba. Dichas marcas o denominaciones comerciales se citan aquí solamente para indicar el empleo de destino de los productos Silca. / Este catálogo queda reservado exclusivamente a los duplicadores profesionales, que utilizan los productos Silca. Las ilustraciones y los datos técnicos de los productos contenidos en el documento se han de considerar indicativos. Silca se reserva el derecho, quedando invariables las características principales de los productos, de modificar todo lo que considere necesario y oportuno para mejorar la calidad de sus artículos. Todos los dibujos y fotografías pertenecen a Silca; según determina la Ley, se prohíbe toda reproducción, total o parcial, sin autorización por escrito de Silca S.p.A. Para cualquier litigio el tribunal competente es el de Treviso, la ley vigente es la italiana.

NOTE LEGALI

In ottemperanza alla normativa vigente in materia di proprietà industriale, si ricorda che - fatta eccezione per "Silca", "dormakaba", "Kaba", "Ilco" e "Advanced Diagnostics" - i marchi o i nomi commerciali citati nel nostro documento sono di esclusiva proprietà di terzi, non affiliati né collegati a Silca S.p.A. o al Gruppo dormakaba. Silca S.p.A. e il Gruppo dormakaba non possiedono alcun diritto di proprietà intellettuale né agli stessi è stata concessa alcuna licenza in relazione a detti marchi o denominazioni commerciali, i quali sono qui citati solo per indicare la destinazione d'uso dei prodotti Silca. Questo catalogo è riservato esclusivamente ai duplicatori professionisti che utilizzano i prodotti Silca. Le illustrazioni e i dati tecnici dei prodotti contenuti nel documento sono puramente indicativi. Silca si riserva il diritto, ferme restando le caratteristiche essenziali dei prodotti, di apportare tutte le modifiche che ritiene necessarie e opportune al fine di migliorare la qualità dei prodotti. Tutti i disegni e le fotografie sono di proprietà di Silca, ogni riproduzione anche parziale, senza autorizzazione scritta di Silca S.p.A., è vietata secondo termini di legge. Per qualsiasi controversia il foro competente è quello di Treviso, la legge vigente è quella italiana.

MENTIONS LÉGALES

Conformément à la législation en vigueur en matière de propriété industrielle, il est rappelé que - à l'exception de "Silca", "dormakaba", "Kaba", "Ilco" et "Advanced Diagnostics" - les marques ou noms commerciaux mentionnés dans notre document sont la propriété exclusive de tiers, non affiliés, ni liés à Silca S.p.A. ou au Groupe dormakaba. Ces marques ou dénominations commerciales ne sont mentionnées ici que pour indiquer la destination des produits Silca. / Ce catalogue est exclusivement réservé aux reproducteurs professionnels qui utilisent les produits Silca. Les illustrations et les données techniques des produits contenues dans le document doivent être considérées comme indicatives. Bien que les caractéristiques essentielles des produits soient invariables, Silca se réserve le droit d'apporter toutes les modifications qu'elle retiendra nécessaires et opportunes afin d'améliorer la qualité de ses produits. Tous les dessins et photos sont propriété Silca et toute reproduction, même partielle, sans l'autorisation écrite préalable de Silca S.p.A. est interdite conformément aux prescriptions légales. Pour tout litige, le tribunal compétent est celui de Trévise, la loi en vigueur est italienne.

NOTÍCIAS LEGAIS

No respeito das normas em vigor relativas à propriedade industrial, lembra-se que - exceptuando "Silca", "dormakaba", "Kaba", "Ilco" e "Advanced Diagnostics" - as marcas ou os nomes comerciais citados no nosso documento são propriedade exclusiva de terceiros, não associados nem ligados à Silca S.p.A. ou ao Grupo dormakaba. Essas marcas ou denominações comerciais são citadas aqui somente para indicar o uso pretendido dos produtos Silca. / Este catálogo é reservado exclusivamente aos profissionais da duplicação que utilizam os produtos Silca. As figuras e as características técnicas dos produtos contidas no documento são facultadas a título indicativo. Mesmo que as características essenciais dos produtos sejam invariáveis, à Silca reserva-se o direito de modificar ser necessário e oportuno os produtos, afim de melhorar a sua qualidade. Todos os desenhos e fotos são propriedade da Silca, e é proibida a sua reprodução mesmo parcial sem a autorização escrita da Silca S.p.A. conforme as prescrições legais. Para qualquer litígio o tribunal competente é o de Treviso, a lei vigente é a italiana.