



NETWORK WITH US



# KEY CUTTING MACHINE CATALOGUE

**2019** VERS.4





## #1 IN THE WORLD

Page 2



Silca	2
Quality and Certifications	2
Key duplication	3
Accessories and spare parts	4
Silca Software	5
Essential tools	6-7

## MECHANICAL KEY CUTTING MACHINES

Page 9



Bravo, Poker Pro, Rekord, Speed, Delta 2000 A, Flash 008, Matrix, Twister II, Swift, Omnia, Fastbit, Lancer Plus, Crown, Delta 2000 FO, Delta 2000 MC, Rekord AY, Duo	10
---	----

Comparison table of key cutting machines based on key type	36, 37
--	--------

## ELECTRONIC KEY CUTTING MACHINES

Page 39



Futura Pro, Futura Auto, Triax Pro, Futura Pro One, Unocode Pro, Futura Edge Unocode 399 Plus, Unocode 299, UC199, Idea	40
---	----

Comparison table of key cutting machines based on key type	52, 53
--	--------

## SEMI-INDUSTRIAL MACHINES

Page 55



Pro-Tech	56
----------	----

Comparison table for the production of Master Key Systems	57
---	----

## AUXILIARY DEVICES

Page 59

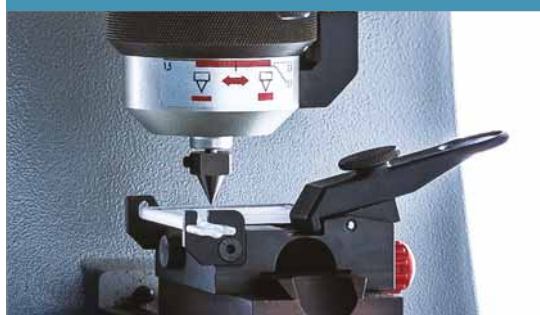

Optika	60
Optika Light	
Marker 2000	



# #1 IN THE WORLD



## SILCA

Silca is the global brand of reference for the production of keys and the production of professional and industrial machines dedicated to key duplication. Silca has been responsible for the most important technological evolutions in key duplication such as the first electronic key cutting machine capable of copying keys by code. Silca machines

are born from a long tradition, from a know-how recognized at a global level and from the expertise and passion of engineers who understand keys in every detail.

## QUALITY AND CERTIFICATIONS

Product quality is fundamental to Silca and we invest continuously to guarantee a level of quality that is both independently certified and designed

to last. The recognition received is the result of Silca's commitment to quality and sustainability.

Silca holds the following standards:

- ISO 9001:2008,
- IATF 16949:2016 (Automotive),
- UNI EN ISO14001:04 (EMS),
- BS-OHSAS 18001:07



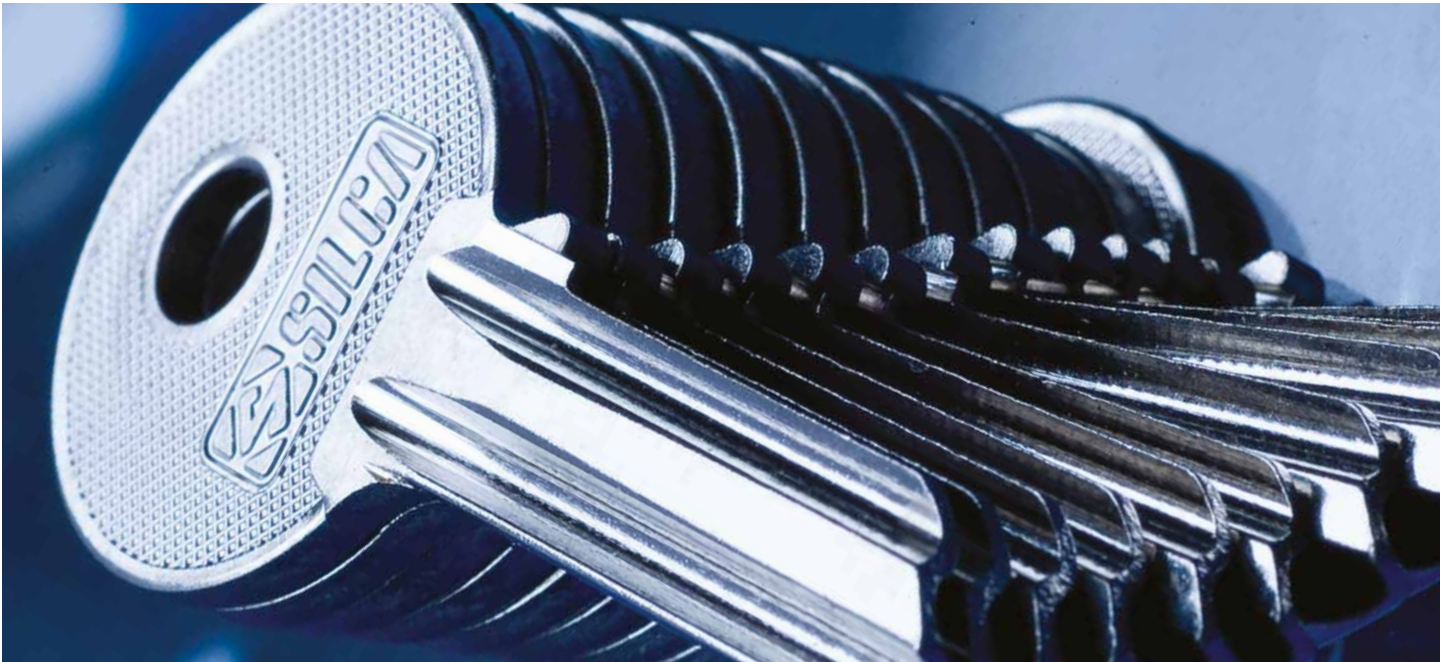

## THE KEY CUTTING MACHINE MOST SUITABLE FOR YOU

This catalogue presents every key cutting machine, both mechanical and electronic, in a standard, easy to read format that gives the machine's key technical and functional characteristics to help you to choose the machine best suited to your needs.

For each machine, in addition to the technical characteristics, the main accessories are also detailed.

## COMPARISON TABLES

These sections developed by Silca experts, allow you to quickly compare the different models in the same family to understand the differences and decide which is the right machine for your business.

The comprehensive final summary table also allows you to see the whole range, across model families, by the types of keys cut.





## OPTIONAL ACCESSORIES

The same passion and attention to detail dedicated to the design and creation of every key cutting machine is also applied to the range of Silca accessories.

Clamps, jaws, feeders: every component is studied based on the structure of the machine for which it will be used.

## ORIGINAL SPARE PARTS

Original Silca spare parts are made from the highest quali-

ty materials, assembled with maximum care and precision tested.

They are made to ensure that optimum performance and precision levels last over time.

## ORIGINAL COSUMABLES

Silca offers a vast range of original consumables like cutters, tracers and brushes.

All Silca consumables conform to the same guaranteed high quality levels that Silca delivers with key cutting machines.

## GUARANTEED COMPONENTS

Original Silca components are designed and produced to respect the requirements of the CE standard. In cases of repair or substitution the CE standard is only guaranteed if original Silca spare parts are used. Silca guarantees to supply parts for 7 years after the discontinuation of a product.





## SILCA KEY PROGRAMS PRO

is the software platform developed by Silca to cut keys with the electronic key cutting machines using the original dimensions set by lock manufacturers, ensuring high quality and precise results. SKP has a modular structure to support different customer needs.

## SILCA SOFTWARE INTERFACE (SSI)

Silca Software Interface is a software module that allows you to import and manage .dat and

.xml data typically used in the production of master key systems. The management of job queues optimizes the phases of key duplication and engraving; useful during installations.

## CODE MAKER

Code Maker is an SKP module for creating key cutting cards not yet present in the Silca database. This function allows you to create cards for flat, dimple, bit, double bit and pump keys.

## SILCA OEM CLIENT

Silca OEM Client (SOC) is a software functionality that allows authorized locksmiths to copy Mottura®, Evva® and Assa® keys. The function ensures full traceability of the duplicates, which are archived and tallied. The OEM transmits the encrypted cutting parameters directly to the machine, guaranteeing the highest level of security in the key duplication service.

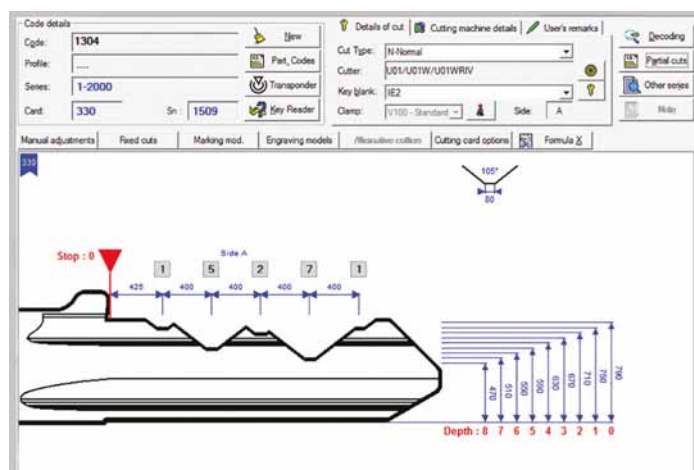
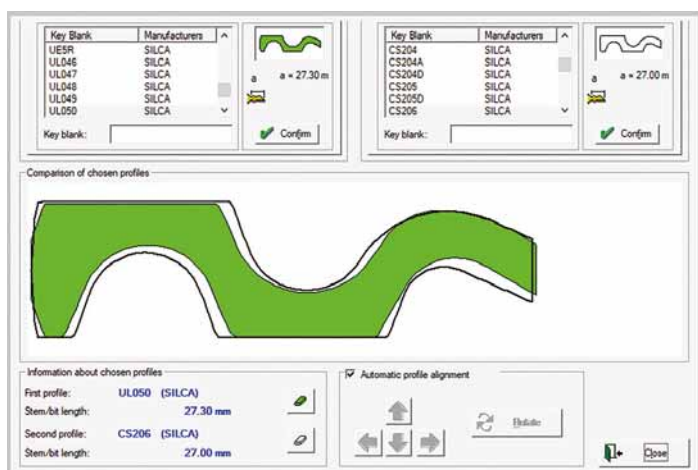



## **MYSILCA APP**

Every day Silca stands by your side with digital solutions that help you identify and use our products. MySilca is the app that provides free and prompt access to the entire range of Silca products, with real time updates on the latest keys, key cutting machines, automotive solutions and remotes. Essential support material such as technical data, brochures, photos and videos are also available 24/7, so you can al-

ways keep our expertise close at hand. MySilca App is optimized for smartphone and tablet, is compatible with Android and iOS systems, and is available in six languages (English, Italian, German, French, Spanish, Portuguese).

## **BARCODE ORDERING**

With MySilca App placing orders is fast and easy. With the 'Barcode Ordering' function you can scan the barcodes of the keys and accessories you

want to purchase and place your order with a simple click. You can contact Silca, your agent or your distributor. You can scan the barcodes directly from the boxes of the products or from the Barcode catalogues available from your Silca representative.

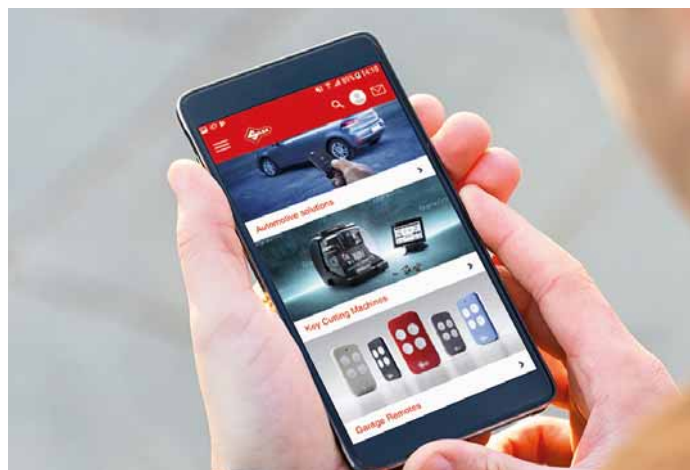





## THE CATALOGUE

The Catalogue is the largest residential and automotive key database worldwide. The breadth and quality of the information available make it the essential tool to find the key you need. You can search residential keys by original make; or by make, model and year if you're browsing automotive keys. Additional filters can be applied to improve the results. You can also create personalized collections and print out

key tags for your display, customizing them with information such as hook position and price.

## REMOTES AND COMPLEMENTARY PRODUCTS SEARCH

The Catalogue includes the assortment of Silca complementary products, such as key rings, engravable key tags, carabiners and snap hooks, together with the range of original residential remotes compatible with Silca Air4. Video tutorials guiding you through the programming pro-

cedures are available for numerous remote models. Registration is free at [thecatalogue.silca.biz](http://thecatalogue.silca.biz).

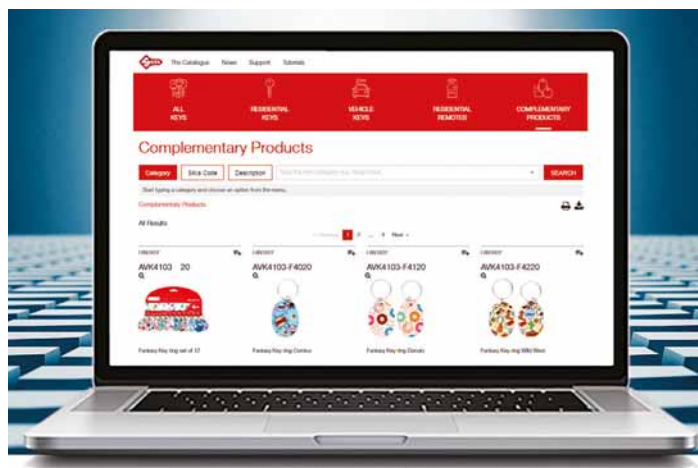
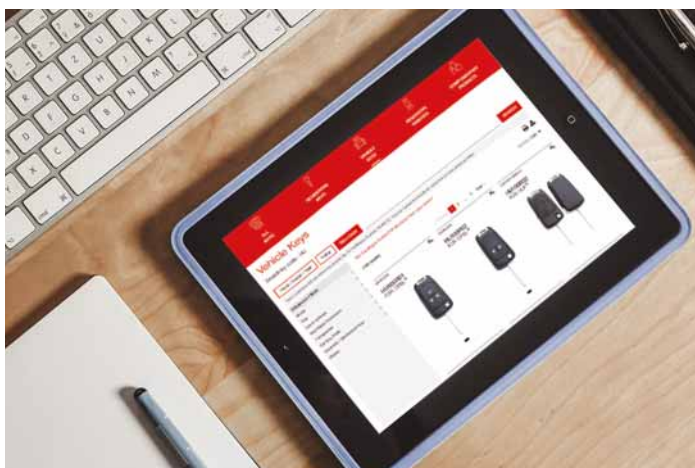





# MECHANICAL KEY CUTTING MACHINES

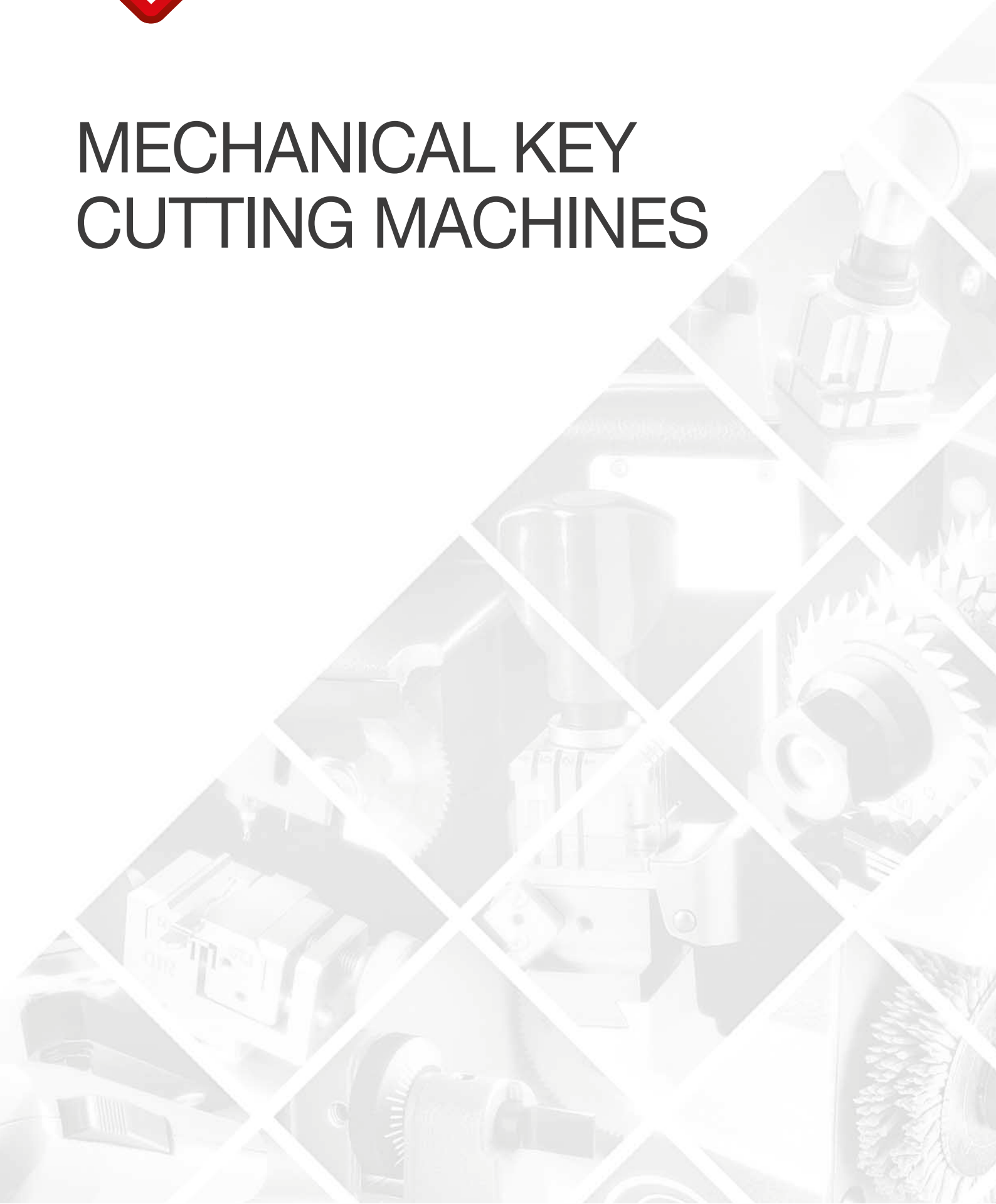



# BRAVO

FOR FLAT, VEHICLE AND CRUCIFORM KEYS



- High quality and versatile clamps
- Carriage safety system
- Automatically activated cutter
- Automatic tightening of the belt
- Electromagnetic safety switch
- Long-lasting components

## MODELS:

Bravo Professional	Bravo W-Max
Bravo Evolution	Bravo Sofer 2P
Bravo Bd Évolution	Bravo D12
Bravo Maxima	
Bravo Maxima Plus	

## KEY TYPES

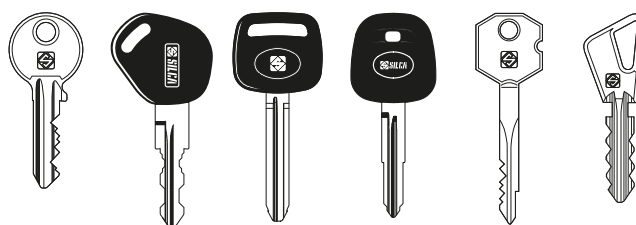

Bravo Evolution: HSS cutter



Bravo Maxima: digital tracer point

FEATURES IN COMPARISON	BRAVO EVOLUTION	BRAVO PROFESSIONAL	BRAVO MAXIMA	BRAVO W-MAX
Revolving 4-sided clamp		●	●	●
Reversible 2/3-sided clamp	●			
Slotted clamps for cutting double-sided keys	●	●	●	●
Burnished metal clamps	●	●	●	●
Tracer point with micrometric adjustment	●	●		
Digital tracer point with micrometric adjustment			●	●
Single speed cutter motor	●	●		
Double speed cutter motor			●	●
Electromagnetic safety switch	●	●	●	●
Carriage safety system	●	●	●	●
Automatically activated cutter	●	●	●	●
Protective shield	●	●	●	●
Dynamometric clamp knob	●	●	●	●
Automatic tightening of the belt	●	●	●	●
Lamp	●	●	●	●
Brush ø 80x20mm	●	●	●	●
Cutter made of Widia				●
Cutter made of HSS (High Speed Steel)	●	●	●	
Weight	kg 21,5	kg 21,5	kg 22,5	kg 22,5



**Bravo Professional: 4-sided clamps**



**Bravo w-max: cutter speed selector**



**Bravo Evolution: micrometric tracer point**



**Bravo Evolution: 3-sided clamps**



# POKER PRO

FOR FLAT, VEHICLE AND CRUCIFORM KEYS



- Practical and ergonomic work station
- Visual and audible warnings
- Sintered, four-sided clamps with Silca patented rotating system
- Protective shield
- Optical reader for quality key cutting
- Optimized cutter wear

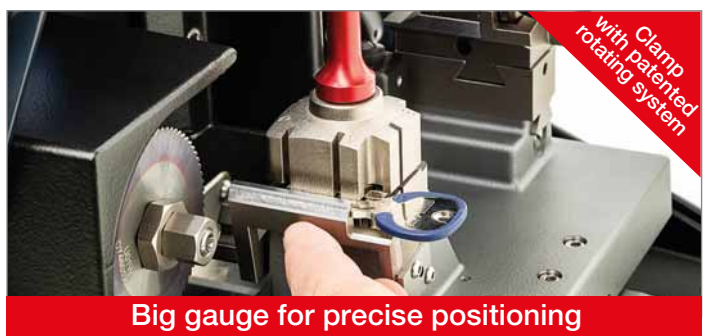
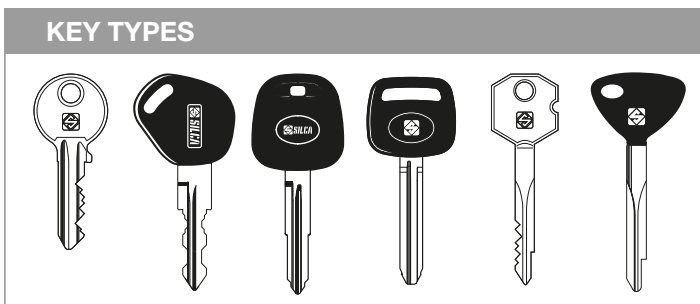



- Sintered, nickel-plated clamps
- Electromagnetic safety switch
- Automatic tightening of the belt
- Cutter made of HSS (High Speed Steel)
- Brush  $\varnothing$  80x15mm

#### KEY TYPES

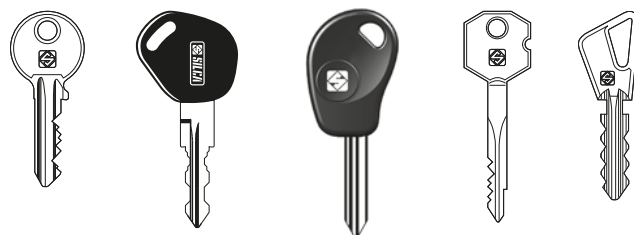

#### MODELS:

Rekord, Rekord S, Rekord Sofer, Rekord D12

FEATURES IN COMPARISON	REKORD	REKORD S
Revolving, sintered, 4-sided clamps with nickel plating	●	●
Tracer point with micrometric adjustment	●	●
Automatically activated cutter		●
Carriage safety system	●	●
Brush $\varnothing$ 80x15mm	●	●
LED lamp	●	●
Weight	kg 19	kg 19



# SPEED

FOR FLAT, VEHICLE AND CRUCIFORM KEYS

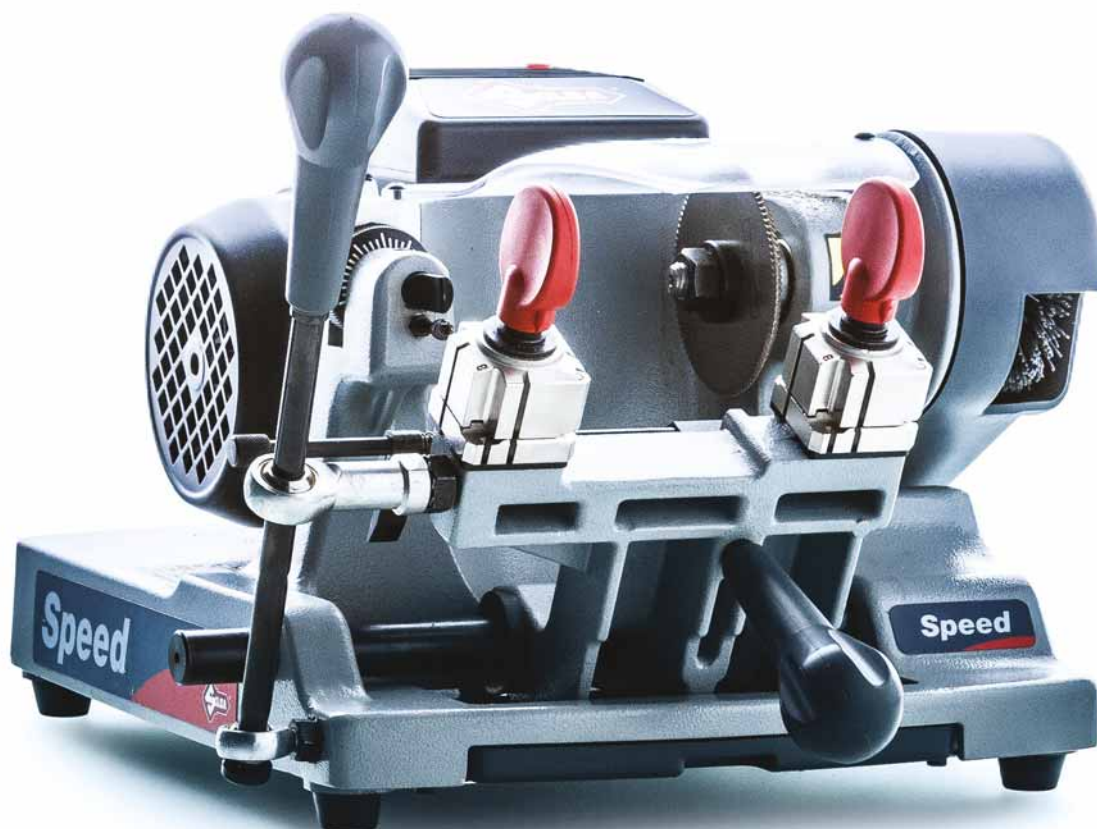

- Sintered, nickel-plated clamps
- Single speed cutter motor
- Electromagnetic safety switch
- Protective shield
- Accessories area
- Swarf tray
- Wide range of optional accessories
- Brush  $\varnothing$  80x16mm

## KEY TYPES

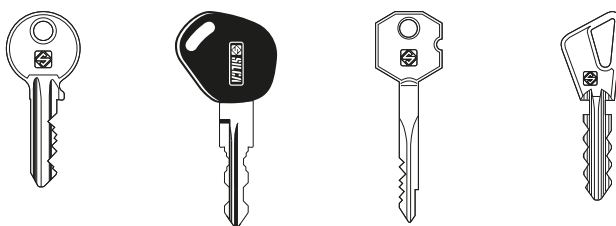

## MODELS:

Speed, Speed S

FEATURES IN COMPARISON	SPEED	SPEED S
Revolving, sintered, 4-sided clamps with nickel plating	●	●
Tracer point with micrometric adjustment	●	●
Electromagnetic safety switch	●	●
Automatically activated cutter		●
Cutter made of HSS (High Speed Steel)	●	●
Fixing bracket	●	●
Weight	kg 14	kg 14



# DELTA 2000 A

FOR FLAT, VEHICLE AND CRUCIFORM KEYS



- Revolving, sintered, 4-sided clamps with nickel plating
- Tracer point with micrometric adjustment
- Electromagnetic safety switch
- Single speed cutter motor
- Fast and automatic key duplication
- Ergonomic knobs and levers
- Swarf tray
- Brush  $\varnothing$  55x15mm
- Weight kg 14

## KEY TYPES



Brush



Revolving, sintered, 4-sided clamps - nickel plating



Tracer point with micrometric adjustment



# FLASH 008

FOR FLAT, VEHICLE AND CRUCIFORM KEYS



- Compact and lightweight
- Revolving, sintered, 4-sided clamps with nickel plating
- Tracer point with micrometric adjustment
- AlTiN-coated cutter made of HSS (High Speed Steel)
- Wear-resistant components
- Fixing bracket
- Brush  $\varnothing$  58x14mm
- Weight kg 6,4

## KEY TYPES

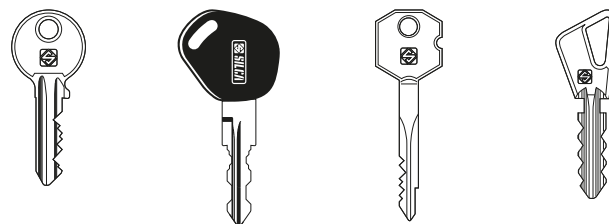

## MODELS:

Flash 008, Flash 008 Extra CEE



Revolving, sintered, 4-sided clamps - nickel plating



AlTiN-coated cutter

# FLASH 008

FOR FLAT, VEHICLE AND CRUCIFORM KEYS

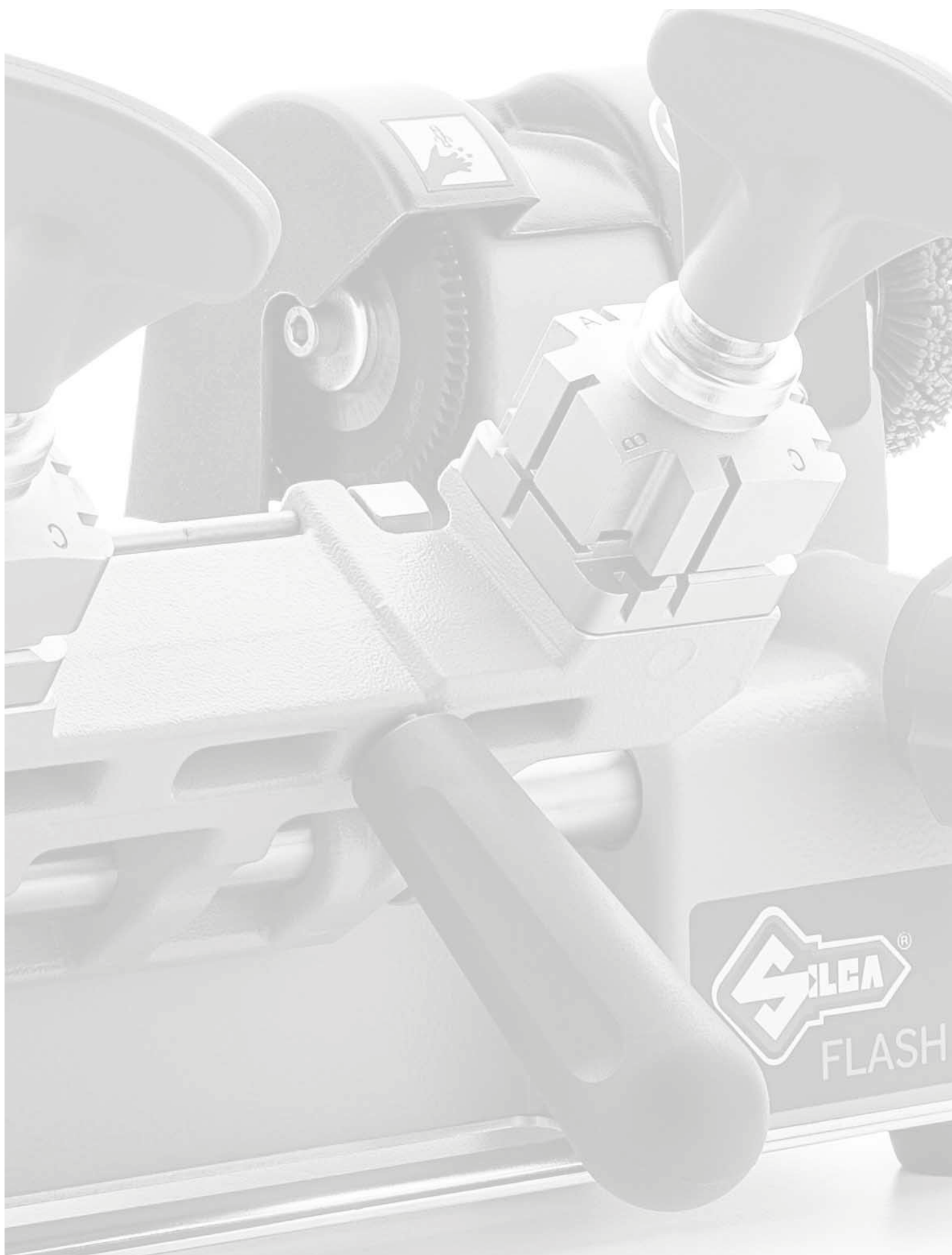



# MATRIX

FOR LASER AND DIMPLE KEYS



- Tilting clamps
- Electromechanical calibration system
- Protective shield
- Cutters made of HSS (High Speed Steel)
- Carriage movements on bearing guides
- Pull-out accessories compartment

## MODELS:

Matrix Pro, Matrix Pro S, Matrix Evo, Matrix Evo S

## KEY TYPES



Keypad display



Cutting tools with identification collar

FEATURES IN COMPARISON	MATRIX PRO	MATRIX PRO S	MATRIX EVO	MATRIX EVO S
Tilting clamp +- 45°	●		●	
Spring loaded tracer point	●	●	●	●
Electromechanical calibration	●	●	●	●
Coated aluminium knobs	●	●		
Polymer knobs			●	●
Electromagnetic safety switch	●	●	●	●
Cutter speed of 6000 rpm	●	●	●	●
Automatically activated cutter	●	●	●	●
Cutting tools with patented identification collar	●	●	●	●
Quick-release system of the cutter and tracer point with self-centering gripper	●	●		
Manual cutter and tracer point release			●	●
Blocking system for X and Y axes carriages	●	●	●	●
Blocking system for Z-axis	●	●	●	●
LED lighting	●	●	●	●
Automatic light switch-on	●	●		
Manual light switch-on			●	●
Roll bar rest for the left hand	●	●	●	●
Tubular key duplication	●	●		
Type HU66 laser key duplication	●	●	●	●
Abus®, Bricard®, Cisa® key duplication	●	●	●	●
Adapter for Fichet® keys (type H)	●		●	
Adapter for Mercedes® keys type HU64		●		●
Accessories area mat	●	●	●	●
Pull-out accessories compartment	●	●	●	●
Weight	kg 24,6	kg 24,6	kg 24,6	kg 24,6



Tilting clamps with 3 seats



Fixed and removable clamp



# TWISTER II

FOR LASER AND DIMPLE KEYS



- Laser and dimple key duplication
- Spring loaded tracer point
- Replaceable jaws of the clamp on the cutter side
- Electromagnetic safety switch
- Cutter speed of 6000 rpm
- Blocking system for X and Z axes
- Carriage movements on bearing guides
- Weight kg 24

## KEY TYPES

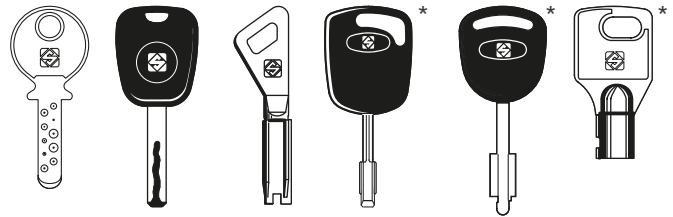

\* Cut with dedicated optional accessories

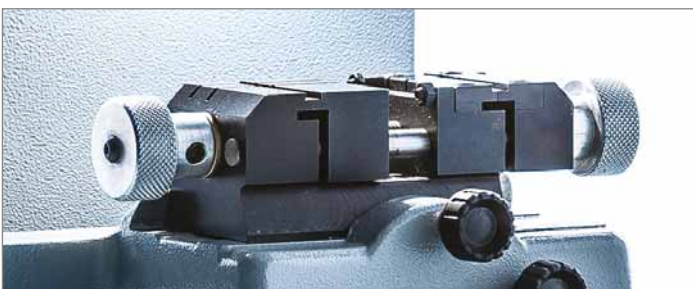

Clamps



Integrated lamp



Spring loaded tracer point

# TWISTER II

FOR LASER AND DIMPLE KEYS





# SWIFT

FOR LASER AND DIMPLE KEYS



- Compact and lightweight
- Resistant and reliable
- Easy to use
- Safe for the user
- Accessories area
- Carriage movements on shafts and bearings

## KEY TYPES

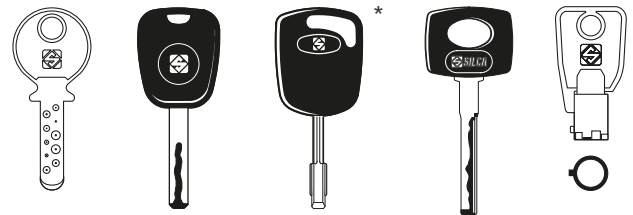

\* Cut with dedicated optional accessories

## MODELS:

Swift, Swift Plus



Swift/Swift Plus



Swift Plus



FEATURES IN COMPARISON	SWIFT	SWIFT PLUS
Replaceable jaws of the clamp on the cutter side	●	●
Spring loaded tracer point	●	●
TiN-coated HSS cutter for laser and dimple keys	●	●
Burnished steel clamps	●	●
Blocking system for tubular key alignment		●
Nickel-plated tracer point ring nut		●
Gauge for installing tubular keys	●	●
Electromagnetic safety switch	●	●
Axes blocking system	●	●
Manual release of the cutter and tracer point	●	●
Cutter speed of 8000 rpm	●	●
Z-axis adjustment ring nut	●	●
Lamp		●
Ergonomic handles	●	●
Long-lasting motor	●	●
Accessories area	●	●
Adapter for Mercedes® type keys supplied as standard		●
Laser, dimple and tubular key duplication	●	●
Weight	kg 12	kg 12

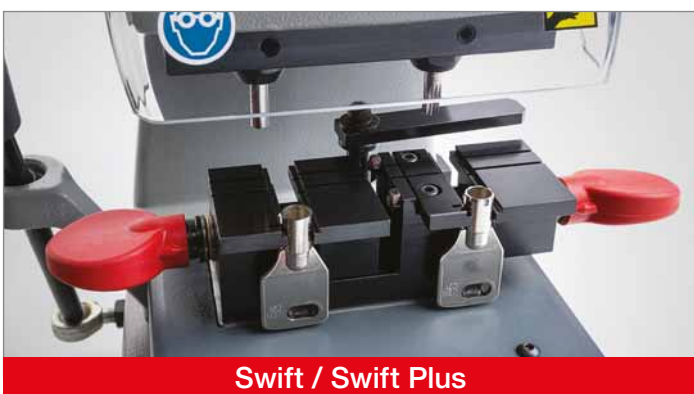
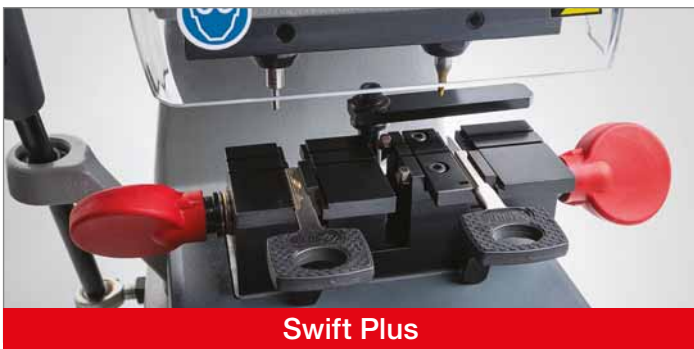



# OMNIA

FOR BIT AND DOUBLE BIT KEYS



- Designed for clamping long-stemmed keys
- Carriage movements by bearing guides
- Automatic safety switch-off
- Tool holder for accessories and tailstocks
- TiN-coated cutter made of HSS (High Speed Steel)
- Excellent view and access to the working area

#### MODELS:

Omnia, Omnia Max, Omnia W-Max, Omnia 650 rpm

#### KEY TYPES

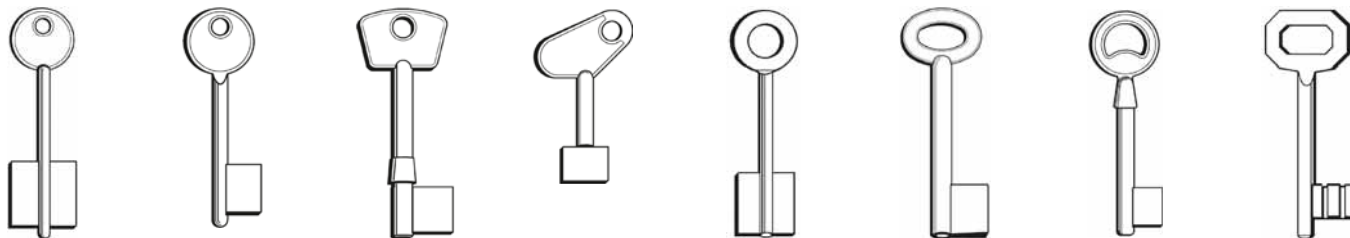

Self-centering clamps



Tool holder for accessories and tailstocks

FEATURES IN COMPARISON	OMNIA	OMNIA 650 rpm	OMNIA MAX	OMNIA W MAX
Cutter made of HSS (High Speed Steel)		●		
TiN-coated HSS cutter	●		●	
Cutter made of Widia				●
Cutter speed	386 rmp	650 rmp	386 rmp	650 rmp
Tailstock for male and female keys	Optional	Optional	Optional	Optional
Knobs and levers made of polymer	●	●		
Coated aluminium knobs			●	●
Vertical cuts carriage	Optional	Optional	●	●
Vertical cuts clamp with dynamometric knob				●
Vertical cuts clamp with standard knob	●	●	●	
Spring loaded tracer point	●	●	●	●
Spring loaded tracer point knob made of polymer	●	●	●	
Chrome-plated spring loaded tracer point knob				●
LED light	●	●	●	●
Protective shield	●	●	●	●
Automatically activated cutter	●	●	●	●
Electromagnetic safety switch	●	●	●	●
Tracer point with micrometric adjustment	●	●	●	●
Single speed cutter motor	●	●	●	●
Brush ø 80x20mm	●	●	●	●
Switch for brush activation	●	●	●	●
Accessories holder	●	●	●	●
Self-centering clamps	●	●	●	●
Tilting clamp on the cutter side	●	●	●	●
Adjustable clamp knobs	●	●	●	●
X-axis blocking knob	●	●	●	●
Weight	kg 32	kg 32	kg 33,5	kg 33,5



Omnia W-Max: vertical cuts carriage



Omnia Max/Omnia W-Max chrome-plated handles



# FASTBIT

FOR BIT AND DOUBLE BIT KEYS

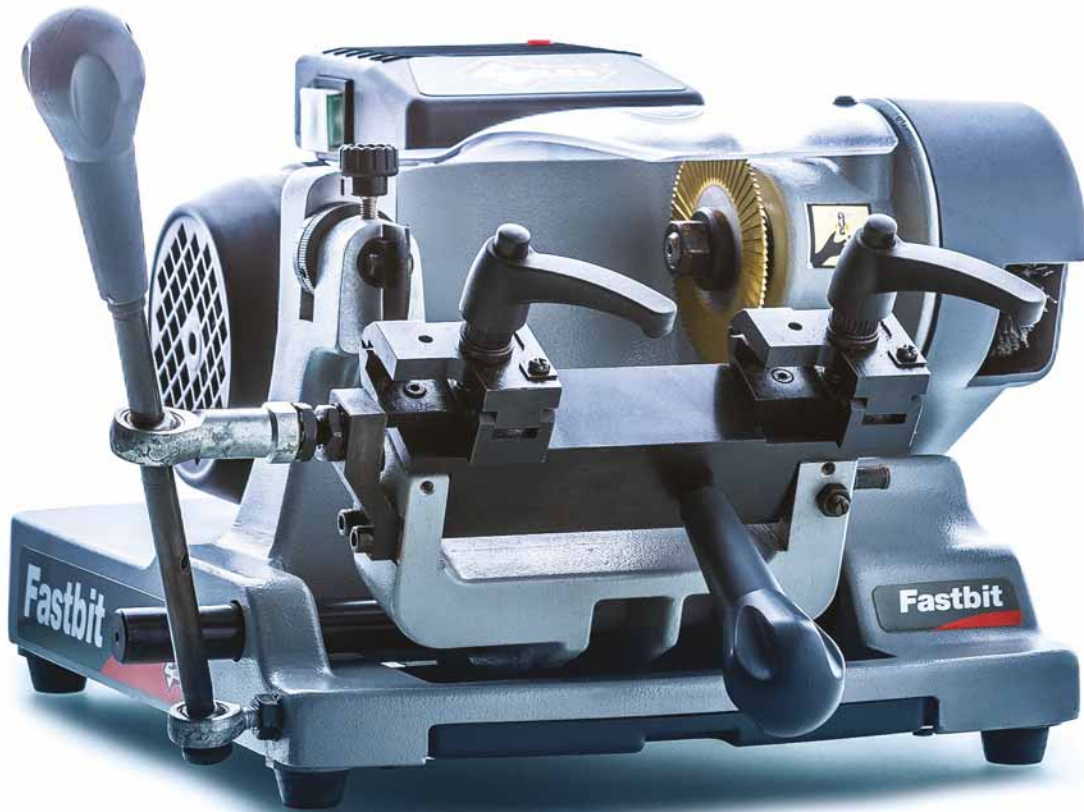

- Spring loaded tracer point
- Electromagnetic safety switch
- Protective cutter shield
- Brush  $\varnothing$  80x16mm

- Ergonomic knobs and levers
- Swarf tray

#### MODELS:

Fastbit, Fastbit II

#### KEY TYPES

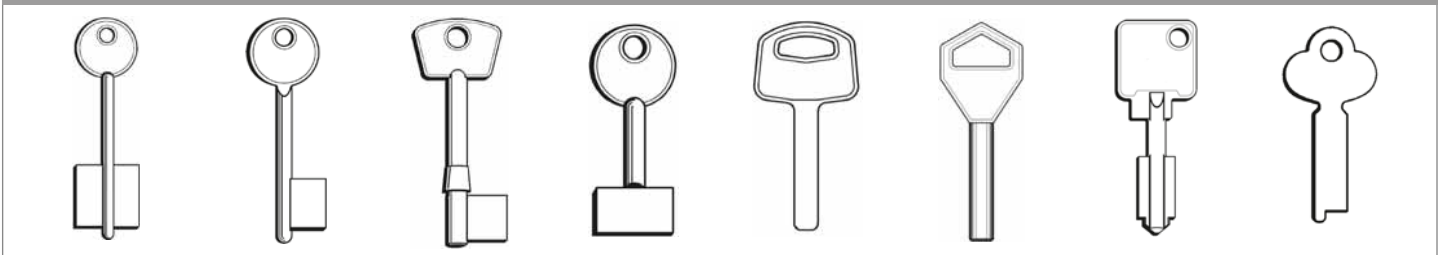

Clamp

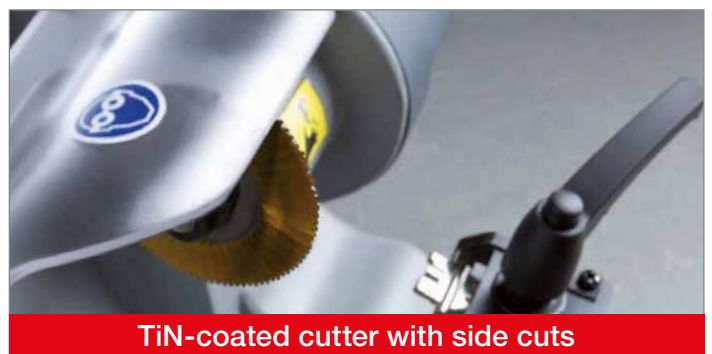

TiN-coated cutter with side cuts

FEATURES IN COMPARISON	FASTBIT	FASTBIT II
Single speed cutter motor	●	●
Tilting clamp on the cutter side	●	●
Spring loaded tracer point	●	●
Tracer point with micrometric adjustment	●	●
Vertical cuts adapter	Optional	Optional
TiN-coated HSS cutter with side cuts	●	
Cutter made of Widia	Optional	●
Cutter speed	600 rpm	600 rpm
Polymer knobs	●	●
Adjustable clamp knob	●	
Ergonomic handles		●
Shaft movement on bushes	●	●
Electromagnetic safety switch	●	●
Mail box key duplication		●
Abloy® key duplication		●
Abus® Granit key duplication		●
Chubb® key duplication		●
Protective cutter shield	●	●
Brush ø 80x20mm	●	●
Swarf tray	●	●
Fixing bracket	●	●
Weight	kg 15,4	kg 15,5



Spring loaded tracer point



HSS cutter



# LANCER PLUS

FOR BIT AND DOUBLE BIT KEYS AND KEYS WITH INTERNAL CUTS

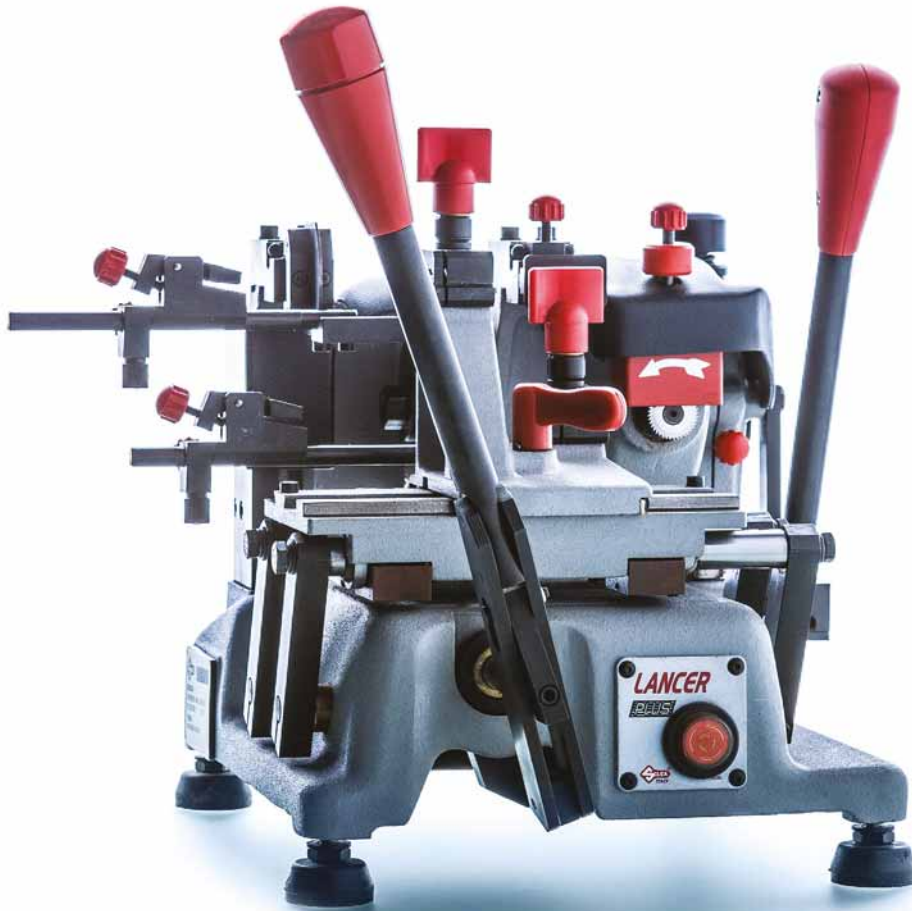

- 2-sided, rotating clamp
- HSS cutter for frontal and side cuts
- Synchronized movement on 3 axes
- Cutter activation microswitch
- Keys with internal cuts duplicated without removing the key
- Weight kg 33

## KEY TYPES

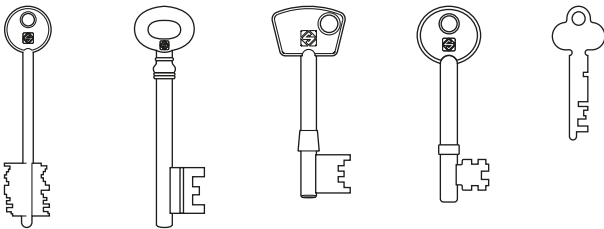

Cutter activation button



Head clamp



Cutter for internal cuts

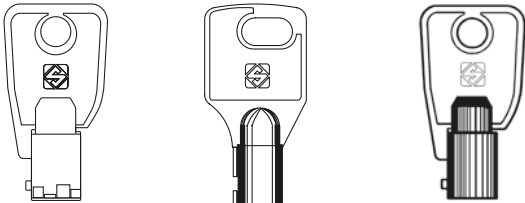
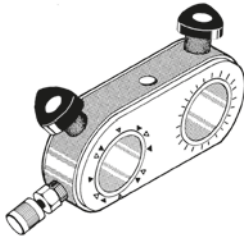

KEY TYPES	OPTIONAL	MODELS:
	 <p>Numerous optional tools available</p>	<p>Crown T10 Crown T15</p>

FEATURES IN COMPARISON	CROWN T10	CROWN T15
Clamp T10	•	Optional
Clamp T15		•
Interchangeable optional clamps	•	•
Self-centering clamp	•	•
Clamp for cutting keys all-round (360°)	•	•
Preset angled positions	6 pos. every 60° - 8 pos. every 60°	6 pos. every 60° - 8 pos. every 45°
Diameter of tubular keys that can be installed	from ø 9,2 to ø 10,2	from ø 6 to ø 12,5
Standard cutter diameter	ø 5,95	ø 2,5 - ø 5,95
Selector for angled position	•	•
Block for angled rotation	•	•
Weight	kg 15,5	kg 15,5



# DELTA 2000 FO

FOR SPECIAL KEYS



- Compact, versatile, easy to use
- Adjustable tracer point
- Single speed cutter motor
- Interchangeable carriage
- Cutter made of HSS (High Speed Steel)
- Brush ø 55x15mm
- Weight kg 14
- Duplicates Tibbe Ford® and Jaguar® type keys

## KEY TYPES

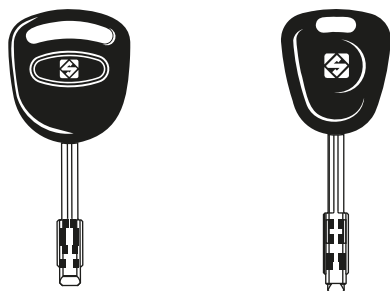

## OPTIONAL

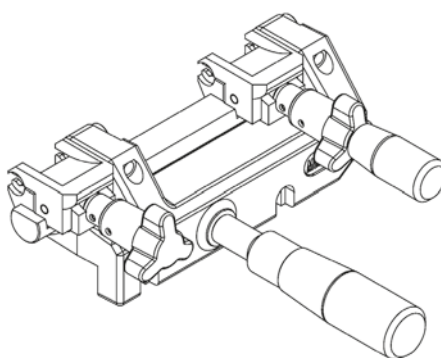

“Multicopy” carriage for copying Ford® (FO19P - FO20P), Abus® (AB32 - AB38P), Abloy® and Ava®-Chubb® type keys



Carriage for duplication by code



HSS cutter



# DELTA 2000 MC

FOR SPECIAL KEYS



- Compact, versatile, easy to use
- Adjustable tracer point
- Single speed cutter motor
- Interchangeable carriage
- Cutter made of HSS (High Speed Steel)
- Brush  $\varnothing$  55x15mm
- Weight kg 14
- Duplicates Ford®, Abus®, Abloy® and Ava®-Chubb®

## KEY TYPES

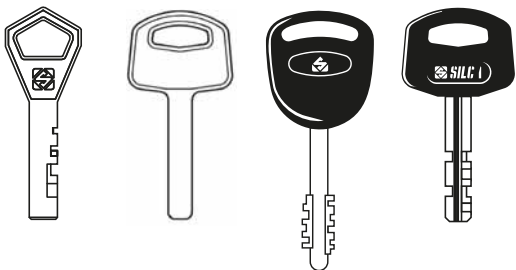

## OPTIONAL

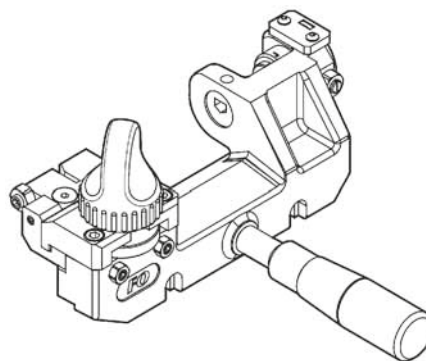

“FO” carriage for duplicating by code Ford® Tibbe® (FO21P) and Jaguar® Tibbe® (TBE1P - TBE2P) type keys



Carriage for copy by original



Tracer point



# REKORD AY

FOR SPECIAL KEYS



- Burnished metal clamps
- Tracer point with micrometric adjustment
- Cutter made of HSS (High Speed Steel)
- Electromagnetic safety switch
- Automatic tightening of the belt
- Protective shield
- LED lighting
- Copy by code
- Brush  $\varnothing$  51x15mm
- Weight kg 14

## KEY TYPES

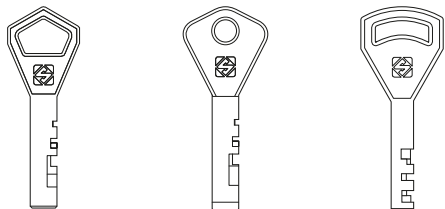

Brush



Carriage for duplication by code



Micrometric tracer point

# REKORD AY

FOR SPECIAL KEYS





# DUO COMBINED

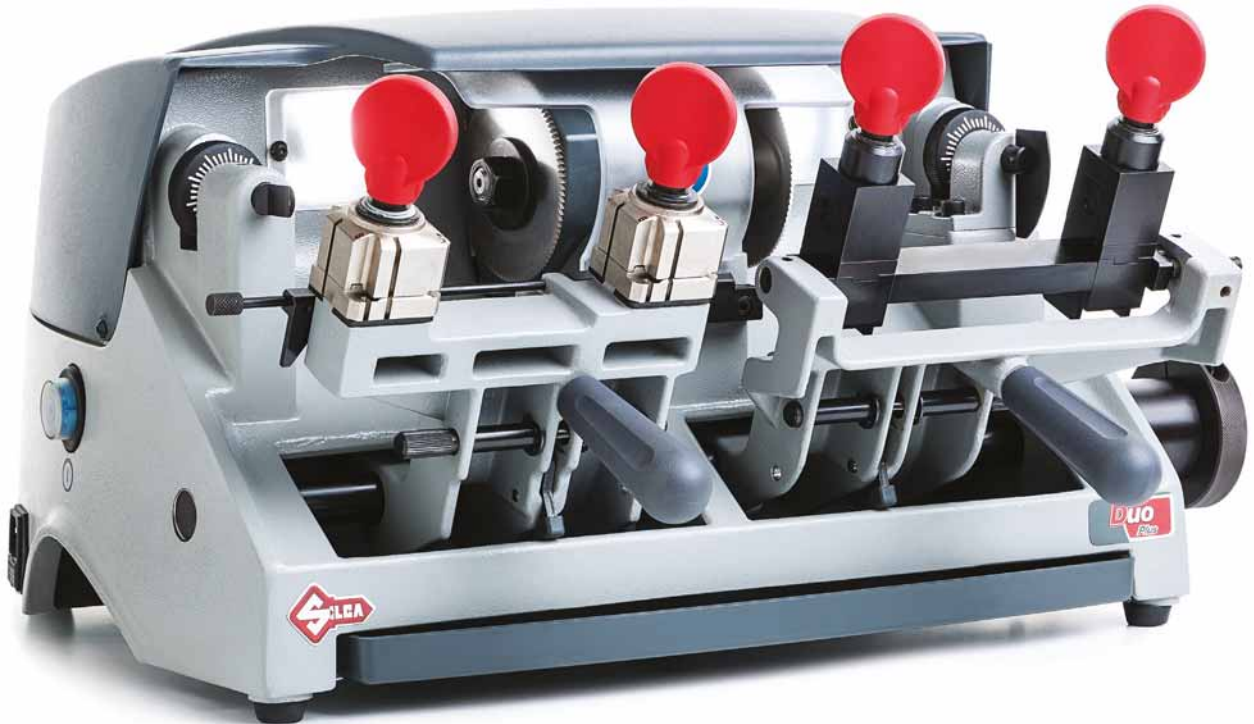

- Double cutting station
- Long-lasting components
- Illumination
- Carriage release system
- Ergonomic handles

## MODELS:

Duo, Duo Plus, Duo Sofer, Duo Power

## KEY TYPES

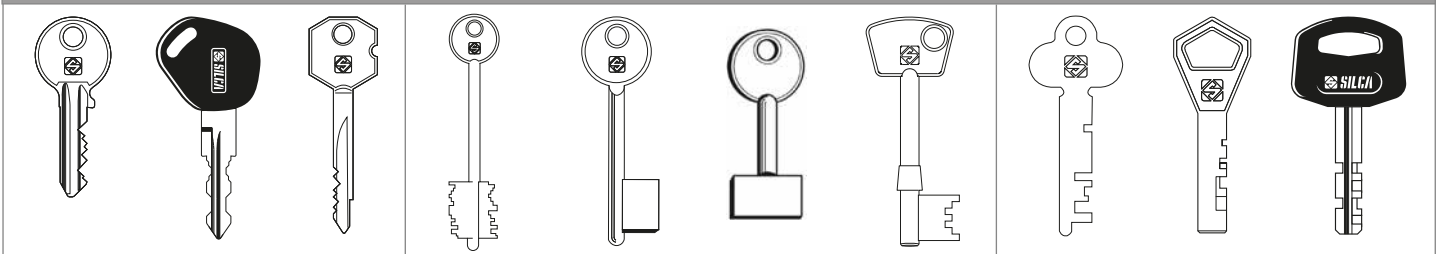

Revolving 4-sided clamps



Revolving 3-sided clamps

FEATURES IN COMPARISON	DUO	DUO PLUS	DUO POWER
Rotating, sintered, 4-sided clamps with nickel plating	●	●	●
Spring loaded tracer point	-	-	-
Single speed cutter motor	●	●	●
Tracer point with micrometric adjustment	●	●	●
Prismatic cutter made of HSS (High Speed Steel)	●	●	●
HSS cutter - thickness 1,25 mm	●	●	●
Electromagnetic safety switch	●	●	●
Ergonomic handles	●	●	●
Long neck pump key duplication	●	●	●
Short neck key duplication			●
Bit and double bit key duplication	●	●	●
Square-stemmed pump key duplication			●
Abloy® key clamping		●	
Chubb® key clamping		●	
Mail box key clamping	●	●	
Abus® Granit key clamping		●	
Tool holder	●	●	●
Brush ø 80x16mm	●	●	●
Lamp	●	●	●
Swarf tray	●	●	●
Weight	kg 23	kg 23	kg 23



**Prismatic cutter made of HSS**



**Swarf tray**



# COMPARISON TABLE OF KEY CUTTING MACHINES BASED ON KEY TYPE

MECHANICAL KEY CUTTING MACHINE	SINGLE SIDED FLAT KEYS	DOUBLE SIDED FLAT KEYS	CRUCIFORM KEYS	LASER KEYS	DIMPLE KEYS	BIT/DOUBLE BIT KEYS	PUMP KEYS	TUBULAR KEYS	KEYS WITH INTERNAL CUTS	KEYS WITH VERTICAL CUTS	BRICARD TYPE KEYS (XBD3, XBD4, XBD7)
Bravo Bd Évolution	●	●	●								●
Bravo D12	●	●	●								●
Bravo Evolution	●	●	●								●
Bravo Maxima	●	●	●								●
Bravo Maxima Plus	●	●	●								●
Bravo Professional	●	●	●								●
Bravo Sofer 2P	●	●	●								●
Bravo W-Max	●	●	●								●
Crown T10								●			
Crown T15								●			
Delta 2000 A	●	●	●								●
Delta 2000 FO											
Delta 2000 MC											
Duo	●	●	●				●			●	●
Duo Plus	●	●	●				●			●	●
Duo Power	●	●	●				●			●	●
Duo Sofer	●	●	●				●			●	●
Fastbit						●	●			●	
Fastbit II						●	●			●	
Flash 008	●	●	●								
Flash 008 Extra CEE	●	●	●								
Lancer						●	●		●	●	
Matrix Evo				●	●			●			
Matrix Evo S				●	●						
Matrix Pro				●	●			●			
Matrix Pro S				●	●			●			
Omnia						●	●			●	
Omnia Max						●	●			●	
Omnia W-Max						●	●			●	
Omnia 650 rpm						●	●			●	
Poker Pro	●	●	●								
Rekord	●	●	●								●
Rekord AY											
Rekord D12	●	●	●								●
Rekord S	●	●	●								●
Rekord Sofer	●	●	●								●
Speed	●	●	●								●
Speed S	●	●	●								●
Swift				●	●			●			
Swift Plus				●	●			●			
Twister II				●	●			●			

● Can be duplicated      ● Can be duplicated with optional accessories

# COMPARISON TABLE OF KEY CUTTING MACHINES BASED ON KEY TYPE



TIBBE TYPE KEYS: FORD/JAGUAR (FO19)	TIBBE TYPE KEYS: FORD/JAGUAR (FO21)	ABLOY TYPE KEYS (AY1, AY2)	ABUS GRANIT/LUMA TYPE KEYS (AB32, AB38)	SOFER TYPE KEYS	AVA/CHUBB TYPE KEYS (ACH1, ACH2, ACH3)	FICHET H TYPE KEYS	BRICARD TYPE KEYS (BD100, BD101, BD102)	ASSA D12 TYPE KEYS	MIWA TYPE KEYS (MIW1, MIW2, MIW3)	SIMPLEX TYPE KEYS	MAIL BOX TYPE KEYS	MECHANICAL KEY CUTTING MACHINE
				●			●	●				Bravo Bd Évolution
				●				●	●	●		Bravo D12
				●				●	●	●		Bravo Evolution
				●				●	●	●		Bravo Maxima
				●				●	●	●		Bravo Maxima Plus
				●				●	●	●		Bravo Professional
				●				●	●	●		Bravo Sofer 2P
				●				●	●	●		Bravo W-Max
												Crown T10
												Crown T15
				●					●	●		Delta 2000 A
●	●	●	●									Delta 2000 FO
●	●	●	●									Delta 2000 MC
	●			●					●	●	●	Duo
●	●	●	●	●	●				●	●	●	Duo Plus
	●			●					●	●		Duo Power
	●			●	●				●	●	●	Duo Sofer
											●	Fastbit
●	●	●	●								●	Fastbit II
				●					●	●		Flash 008
				●					●	●		Flash 008 Extra CEE
					●						●	Lancer
						●						Matrix Evo
						●						Matrix Evo S
						●						Matrix Pro
						●						Matrix Pro S
											●	Omnia
											●	Omnia Max
											●	Omnia W-Max
											●	Omnia 650 rpm
												Poker Pro
				●				●	●	●		Rekord
		●										Rekord AY
				●				●	●	●		Rekord D12
				●				●	●	●		Rekord S
				●				●	●	●		Rekord Sofer
				●					●	●		Speed
				●					●	●		Speed S
	●					●						Swift
	●											Swift Plus
						●						Twister II

● Can be duplicated    ● Can be duplicated with optional accessories







# ELECTRONIC KEY CUTTING MACHINES

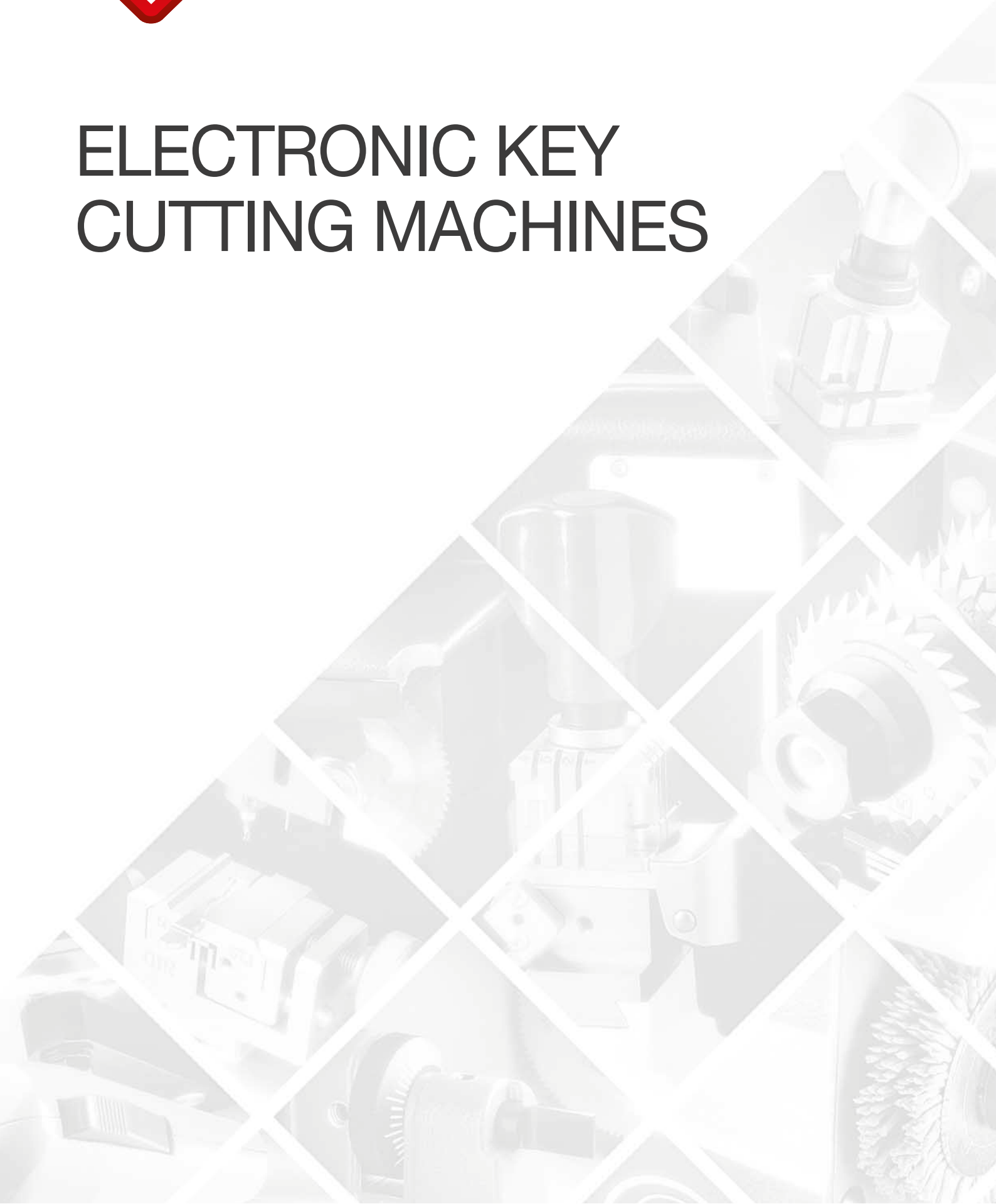



# FUTURA PRO FOR FLAT, VEHICLE, LASER, DIMPLE, CRUCIFORM KEYS AND ENGRAVING

DOUBLE cutting station



- Lightweight and compact
- Long-lasting components
- Highly reliable
- Silca precision and design
- Tablet supplied
- Fast cutting cycle
- Software updates always available
- Best selling machine with double cutting station

**MODELS:**

- Futura Pro
- Futura Pro Engraving
- Futura Pro Automotive Kit
- Futura Pro Unlimited
- Futura Pro Japan

FUTURA PRO KEY TYPES	ENGRAVING
<p>See the comparative table at the end of the electronic key cutting machine section to identify the key types cut by each model</p>	<p>* Cut with dedicated optional accessories</p> <p>Standard equipment for Futura Pro Engraving. Optional equipment for Futura Pro, Futura Pro Automotive, Futura Pro One</p>

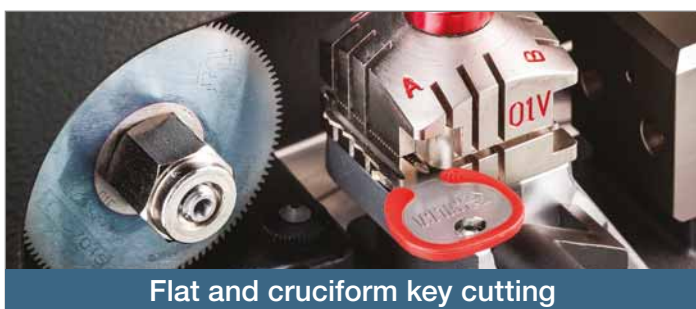

# FUTURA PRO FOR FLAT, VEHICLE, LASER, DIMPLE, CRUCIFORM KEYS AND ENGRAVING



FEATURES IN COMPARISON	FUTURA PRO	FUTURA PRO ENGRAVING	FUTURA PRO AUTOMOTIVE KIT	FUTURA PRO UNLIMITED
Nickel-plated, 4-sided clamp for flat keys	●	●	●	●
Nickel-plated clamp for laser and dimple keys	●	●	●	●
Retractable tracer point for laser and dimple keys	●	●	●	●
Interchangeable jaws of the clamp for laser and dimple keys	●	●	●	●
Cutter speed for laser and dimple keys	12100 rpm	12100 rpm	12100 rpm	12100 rpm
Prismatic cutter speed for flat keys	1585 rpm	1585 rpm	1585 rpm	1585 rpm
Detection of the gauge for flat keys	●	●	●	●
Detection of the mobile tracer	●	●	●	●
Patented rotating system of the flat key clamp	●	●	●	●
Flat key decoding through patented optical reader	●	●	●	●
Assisted double sided flat key decoding	●	●	●	●
Cutting shaft for broken keys	●	●	●	●
Automotive equipment			●	●
Residential key database	●	●	●	●
Automotive key database	●	●	●	●
Automatic calibration system	●	●	●	●
6 months free database software updates	●	●	●	
Unlimited database updates included				●
Customer code tables import	●	●	●	●
Software functions for engraving	●	●	●	●
Engraving equipment		●		●
Favourite cards management	●	●	●	●
Flat key copy by original	●	●	●	●
Removable 10" tablet	●	●	●	●
Patented tablet stand	●	●	●	●
Protective shield that slides back inside the machine	●	●	●	●
Weight	kg 20	kg 20	kg 20	kg 20



Automotive laser key cutting



Engraving of keys and medals



# FUTURA AUTO

FOR AUTOMOTIVE KEYS

SINGLE cutting station



- Developed especially for the automotive business
- Cuts all types of vehicle keys
- Four-sided clamp with patented rotating system
- Optimized cutting cycles
- Decoding by electric contact
- Interchangeable clamps
- Clamp for flat keys
- Clamp for laser keys
- Patented tablet support
- Software-guided duplicating procedures
- Optional accessories available for Tibbe® and Simplex® keys

## FUTURA AUTO KEY TYPES



\* Can be duplicated with dedicated optional accessories



Laser key cutting



Flat key cutting

Clamp with patented rotating system



Patented  
tablet support

## Futura Auto Software

- Fast key search function
- “Partial cuts” function to identify the correct key cuts
- Key cut preview
- Compatible with InstaCode
- Integrated key hook position
- Easy to update



Key cut on the back

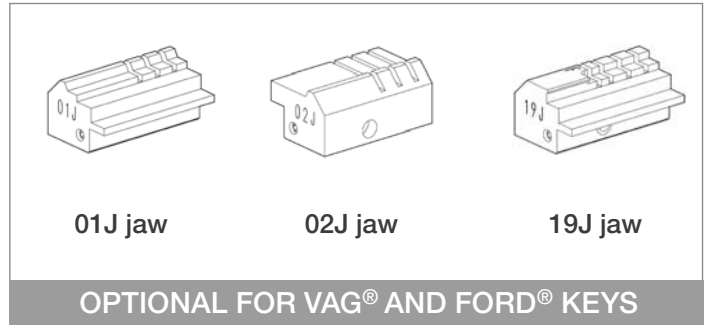

01J jaw

02J jaw

19J jaw

OPTIONAL FOR VAG® AND FORD® KEYS



03R clamp for Ford® keys



02R clamp for tubular keys



# TRIAX PRO

FOR LASER AND DIMPLE KEYS, AND ENGRAVING



- Top performance, precision and quality
- Long-lasting components made of nickel-plated and stainless steel
- Cut keys counter for each cutter
- Easy-change jaws
- Quick-release cutter change system
- Weight kg 51,5

## OPTIONAL CLAMPS FOR ANGLED CUTS

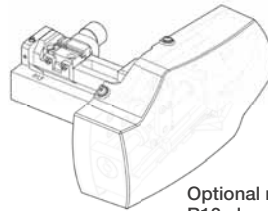

Optional motorized R13 clamp

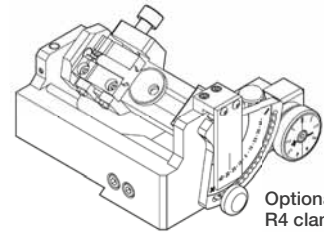

Optional manual R4 clamp

## KEY TYPES

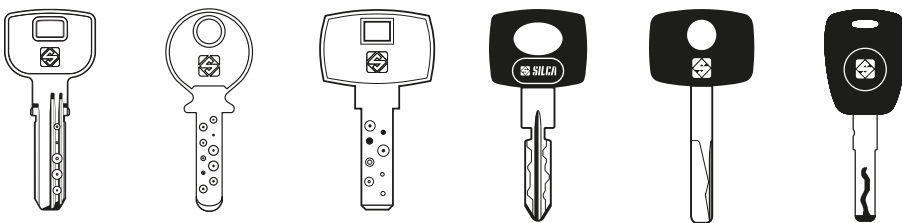

## ENGRAVING

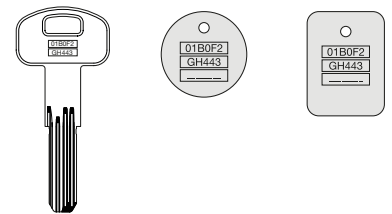

Key cutting



Engraving

# FUTURA PRO ONE

FOR LASER AND DIMPLE KEYS



SINGLE  
cutting  
station

- Lightweight and compact
- Long-lasting components
- Highly reliable
- Tablet supplied
- Fast cutting cycle
- Single cutting station
- Interchangeable jaws
- Wide range of optional accessories
- Integrated cutter holder
- 2 USB ports
- Wi-Fi connection
- Weight kg 17

## KEY TYPES

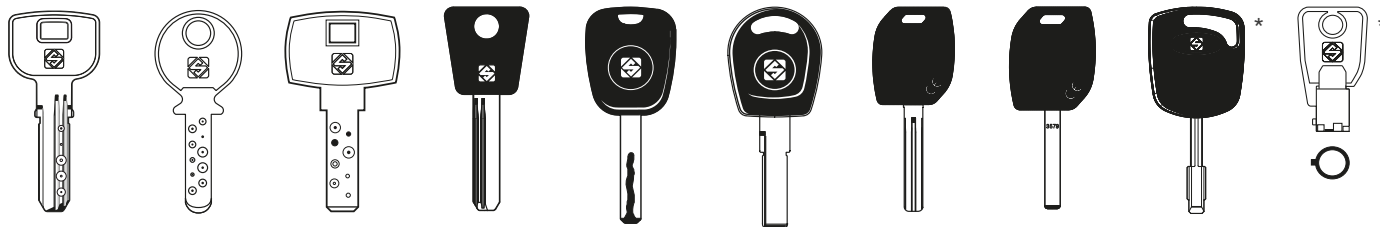

\* Can be duplicated with dedicated optional accessories

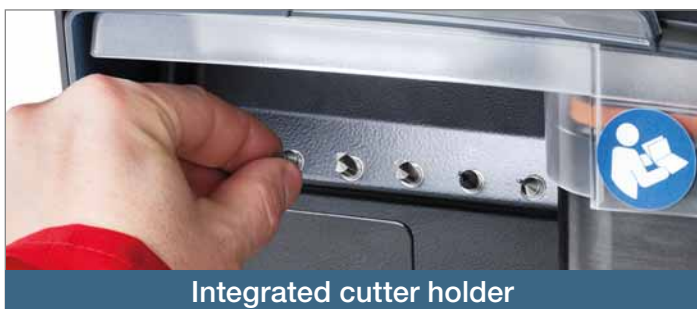

Integrated cutter holder



Laser key cutting



# UNOCODE PRO

FOR FLAT, VEHICLE AND CRUCIFORM KEYS



- Top performance, precision and quality
- Widia cutter with AlCrN coating
- Patented laser decoder
- Patented dynamometric clamp knob
- Double clamp for copy by original and decoding
- Patented clamp blocking system
- Customisable speed of carriage movements
- Can be used in Stand Alone or with the Silca Code Program
- Various optional clamps and adapter ● Weight kg 38

## KEY TYPES

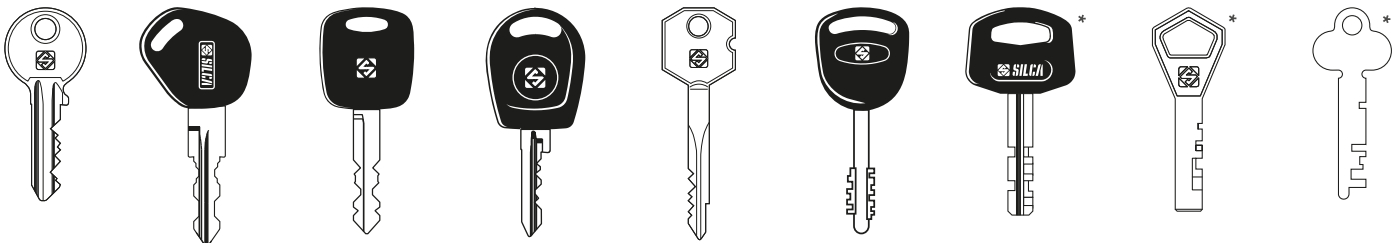

\* Can be duplicated with dedicated optional accessories



Nickel-plated, 4-sided clamps



Accessories area



# FUTURA EDGE

FOR FLAT, VEHICLE AND CRUCIFORM KEYS



SINGLE cutting station



- Lightweight and compact
- Highly reliable
- Patented laser reader
- Tablet supplied
- Fast cutting cycle
- Wi-Fi connection
- Long-lasting components
- Single cutting station
- Weight kg 16

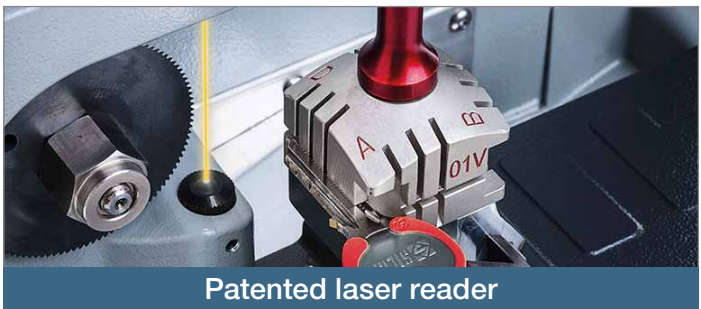
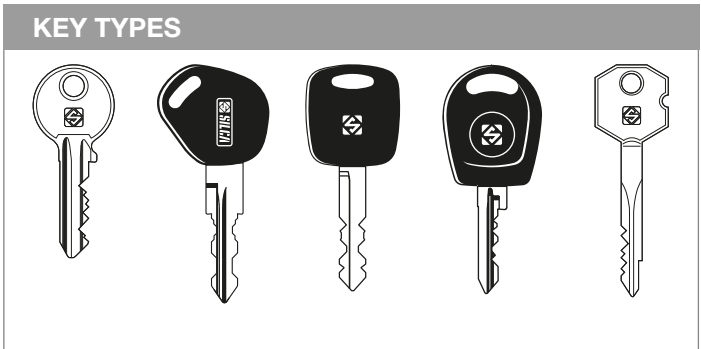



# UNOCODE 399 PLUS

FOR FLAT KEYS WITH METAL HEAD



- Perfect for duplicating large quantities of keys and master key systems
- Accessible wide working area
- Pneumatic feeder with high production rates
- Sorter set (FIFO) for key collection (optional)
- Key stacker with high loading capacity (optional)
- Swarf vacuum system (optional)
- External device with start/stop push button
- Can be used in Stand Alone or with the Silca Code Program
- .DAT file management for master key systems
- Weight kg 51

## KEY TYPES



Wide graphic display



Wide cutter with AlCrN coating

# UNOCODE 299

FOR FLAT, VEHICLE AND CRUCIFORM KEYS



- Solid, precise and high quality
- Simple and guided clamp calibration
- Wide database of residential and vehicle keys
- 4-sided clamp for flat keys
- Blank key detection by electric contact
- Accessible wide working area
- Duplication by code only
- Can be used in Stand Alone or with the Silca Code Program
- Patented clamp blocking system
- Weight kg 34,5

## KEY TYPES

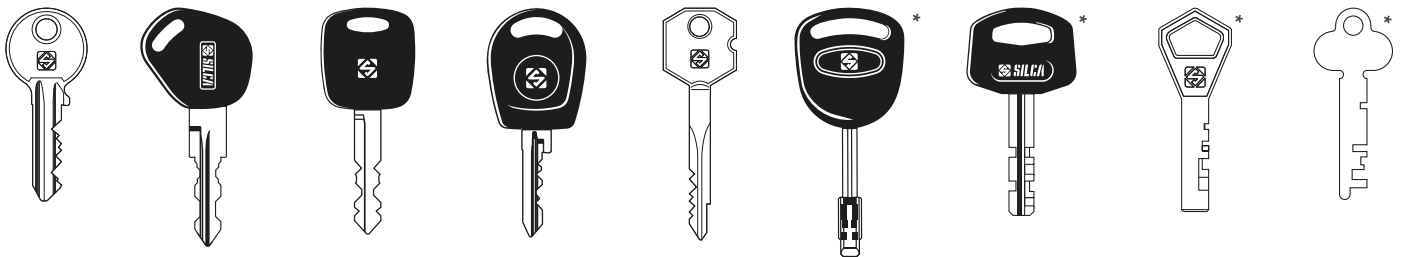

\* Can be duplicated with dedicated optional accessories



Slotted clamp for vehicle keys



Keypad



# UC199

FOR FLAT, VEHICLE AND CRUCIFORM KEYS



- Slotted, 4-sided clamp for single and double sided keys
- Patented laser reader for flat keys
- Flat keys copied by original in one single operation
- Double clamp for copy by original and decoding
- Recognition of installed clamp
- Can be used in Stand Alone or with the Silca Code Program
- Optional: automatic feeder set (no compressed air needed)
- Movable safety shield
- Weight kg 43

## KEY TYPES

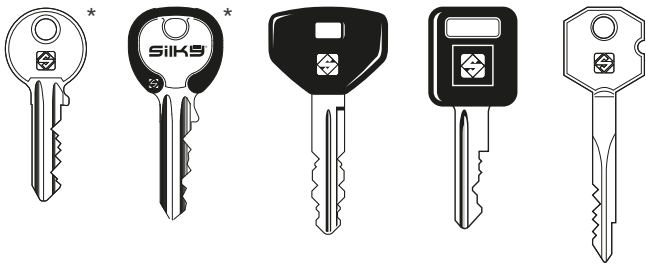

\* Use with automatic feeder

## OPTIONAL



Automatic key feeder



Frontal start-stop button



Cutter side clamp



- Precise results when cutting steel and brass keys
- 360° rotating clamp, compatible with many optional accessories
- Blank key detection by electric contact
- Various optional tools for pump keys, central stop keys and others
- Patented laser decoder
- Duplicates by original, by decoding and by copy
- Stand-Alone use or with Silca Idea Program
- Job queue management via PC
- Weight kg 43

## KEY TYPES

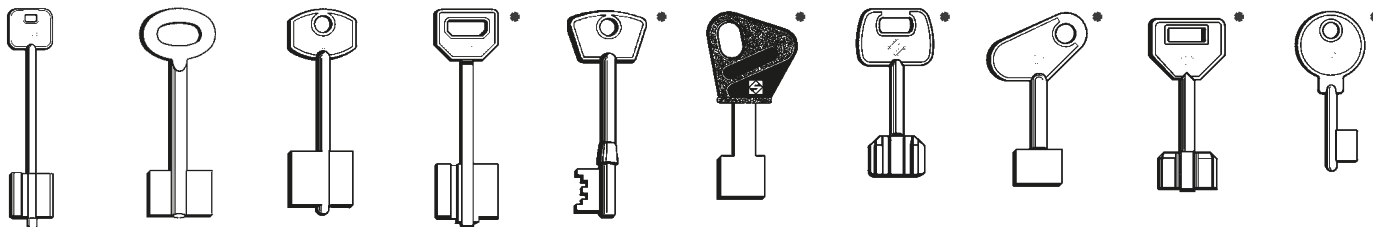

\* Can be duplicated with dedicated optional accessories



Clamp



Keypad



# COMPARISON TABLE OF KEY CUTTING MACHINES BASED ON KEY TYPE

ELECTRONIC KEY CUTTING MACHINE	SINGLE SIDED FLAT KEYS	DOUBLE SIDED FLAT KEYS	CRUCIFORM KEYS	LASER KEYS	DIMPLE KEYS	BIT/DOUBLE BIT KEYS	PUMP KEYS	TUBULAR KEYS	KEYS WITH INTERNAL CUTS	KEYS WITH VERTICAL CUTS	BRICARD TYPE KEYS (XBD3, XBD4, XBD7)	TIBBE TYPE KEYS; FORD/JAGUAR (F019)
Futura Auto	●	●		●	●			●				
Futura Pro	●	●	●	●	●			●				
Futura Pro Automotive Kit	●	●	●	●	●			●				
Futura Pro Edge	●	●	●									
Futura Pro Engraving	●	●	●	●	●			●				
Futura Pro One			●	●	●			●				
Futura Pro Unlimited	●	●	●	●	●			●				
Idea						●	●					●
Triax Pro				●	●			●				
UC199	●	●	●									
Unicode Pro	●	●	●									●
Unicode 399 Plus	●	●	●									●
Unicode 299	●	●	●									●



● Can be duplicated

● Can be duplicated with optional accessories

# COMPARISON TABLE OF KEY CUTTING MACHINES BASED ON KEY TYPE



TIBBE TYPE KEYS: FORD/JAGUAR (F021)	ABLOY TYPE KEYS (AY1, AY2)	ABUS GRANIT/LUMA TYPE KEYS (AB32, AB38)	SOFER TYPE KEYS	AVA/CHUBB TYPE KEYS (ACH1, ACH2, ACH3)	FICHET H TYPE KEYS	MERCEDES TYPE KEYS	BRICARD TYPE KEYS (BD100, BD101, BD102)	ASSA D12 TYPE KEYS	MIWA TYPE KEYS (MIW1, MIW2, MIW3)	SIMPLEX TYPE KEYS	MAIL BOX TYPE KEYS	ELECTRONIC KEY CUTTING MACHINE
●										●		Futura Auto
●						●		●	●	●		Futura Pro
●						●		●	●	●		Futura Pro Automotive Kit
								●	●	●		Futura Pro Edge
●						●		●	●	●		Futura Pro Engraving
●						●		●	●			Futura Pro One
●						●		●	●	●		Futura Pro Unlimited
●	●	●		●								Idea
●					●	●						Triax Pro
●			●					●	●	●		UC199
●	●	●						●	●	●	●	Unocode Pro
●	●	●						●	●	●	●	Unocode 399 Plus
●	●	●	●					●	●	●	●	Unocode 299



● Can be duplicated      ● Can be duplicated with optional accessories







# SEMI-INDUSTRIAL KEY CUTTING MACHINES

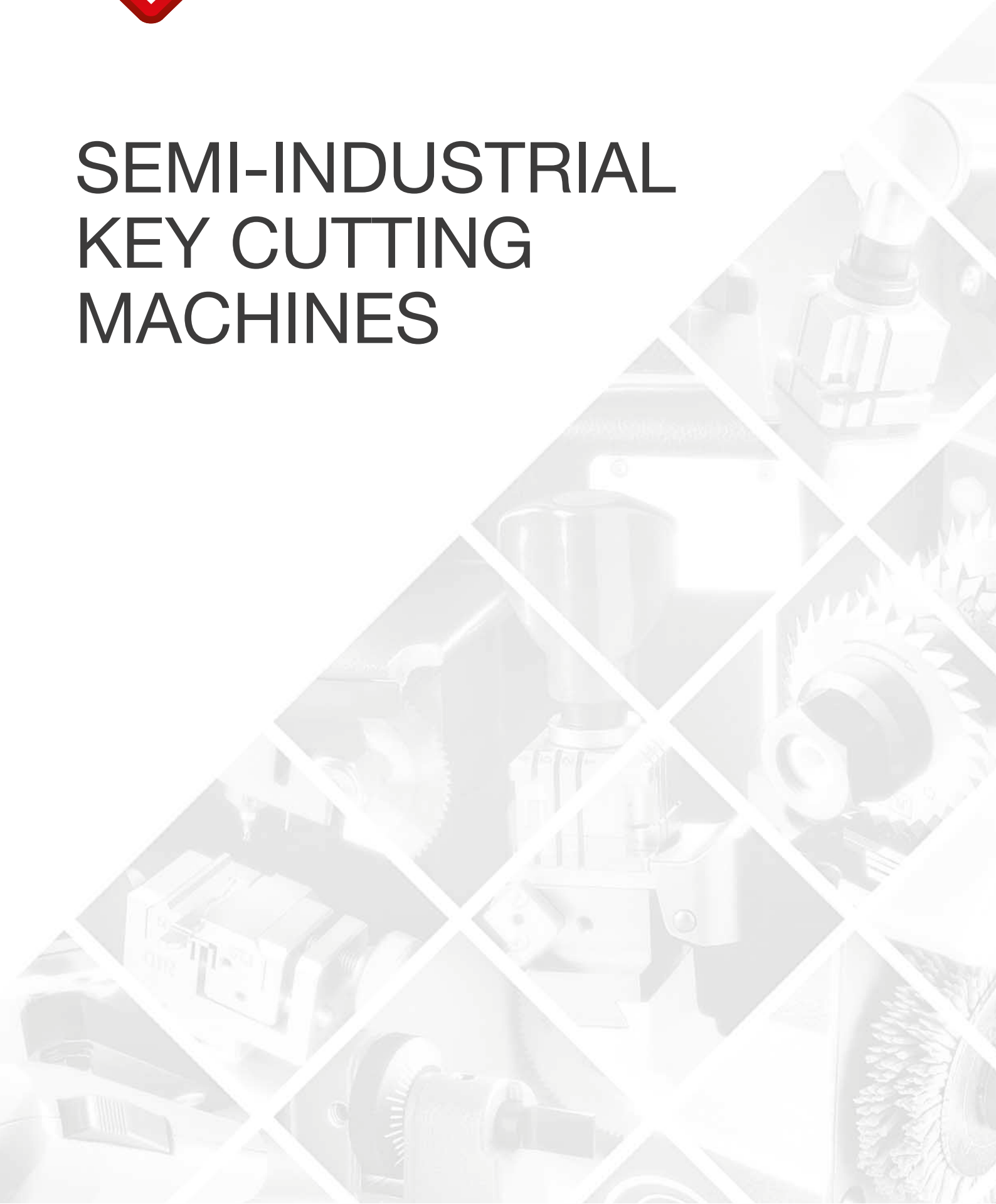



# PROTECH

FOR THE PRODUCTION OF MASTER KEY SYSTEMS



- Fully automatic
- Modular and customizable
- Double station for cutting flat, dimple and laser keys, and for engraving
- Vertical stacker for large quantities of keys
- The best solution for cutting MKS (Master Key Systems)
- Integrated key sorter
- Tilting clamp
- Automatic engraving
- Stack light
- Swarf vacuum system



Removable storage unit



Automatic feeder

FEATURES IN COMPARISON	M159 PLUS	M059 PLUS	D159 PLUS	D149 PLUS	F039 PLUS	E049 PLUS	S169 PLUS	R069	S169	M159	M157	M059	M057	D159	D057	D149	D047	F039
30% faster	•	•	•	•	•	•	•											
Tool changer with 6 positions	•		•	•			•		•	•	•			•		•		
Flat and dimple key cutting station	•	•					•		•	•	•	•	•					
Dimple key cutting station			•	•										•	•	•	•	
Flat key cutting station					•	•		•										•
Tilting clamp	•	•	•							•	•	•	•	•	•			
Fixed clamp				•		•	•		•							•	•	
Engraving with diamond tips	•	•	•	•	•					•	•	•	•	•	•	•	•	•
Engraving with cutter						•	•	•	•									
Abloy® key cutting station							•	•	•									
Sorter tray	•	•	•	•	•	•	•	•	•	•		•		•		•		•







# AUXILIARY DEVICES

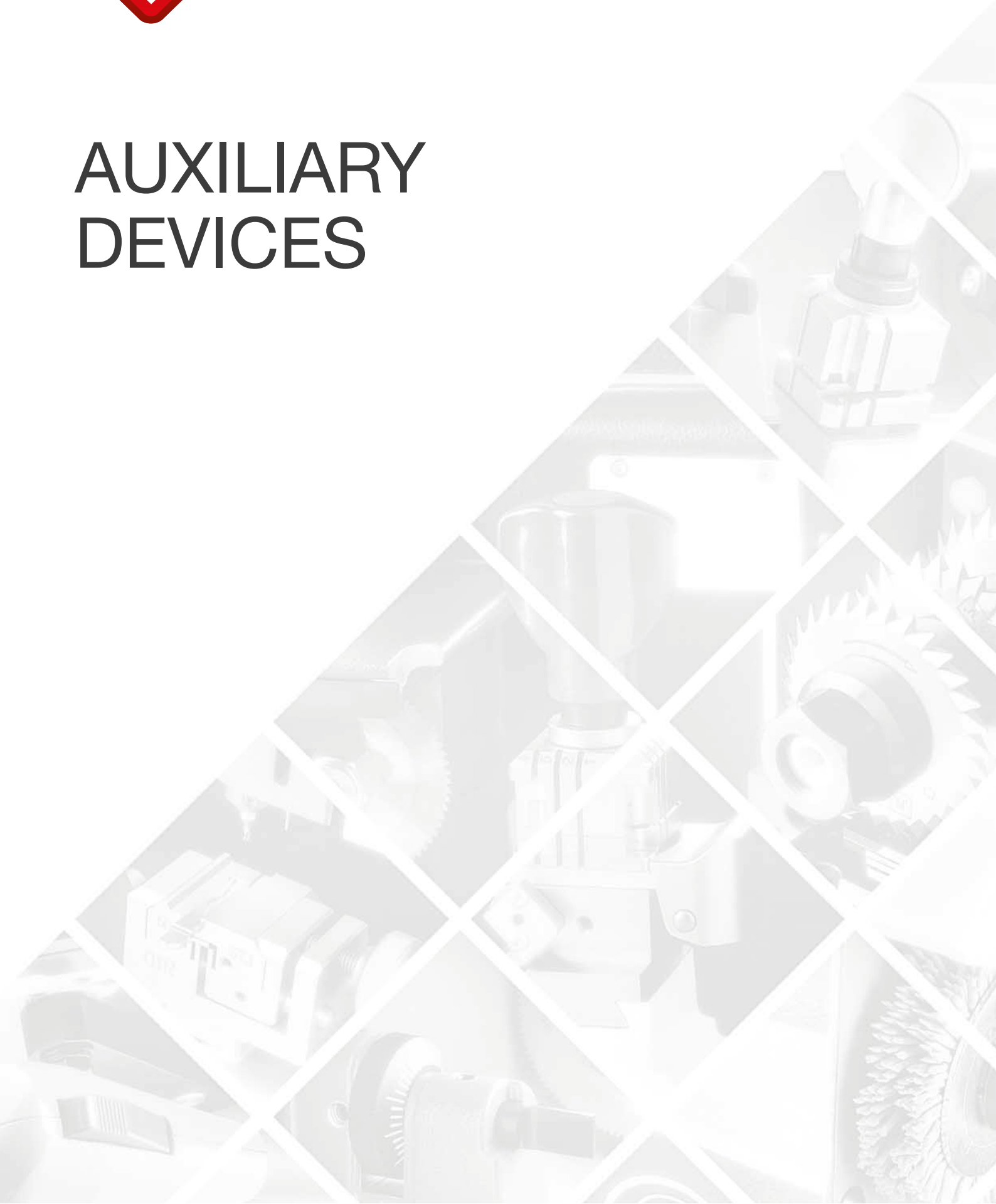



# OPTIKA

KEY READING AND KEY COMPARING DEVICE



## KEY TYPES

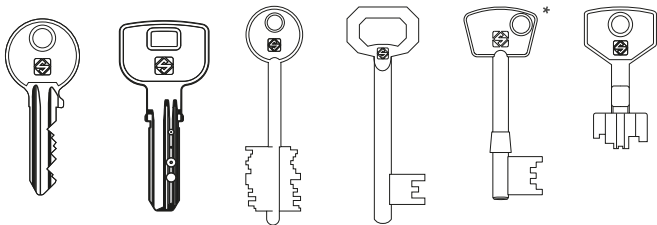

## MODELS:

Optika, Optika Light



Shading device for double bit keys



Keypad

FEATURES IN COMPARISON	OPTIKA	OPTIKA+KEY READER PRG.	OPTIKA LIGHT
Key profile reading	●	●	●
Management of alternative and comparative key profile lists	●	●	●
Comparative search type "fine"	●	●	
Comparative search type "std"	●	●	
Comparative search type "extended"	●	●	
Comparative search type "extra"		●	
Original profile and key cutting comparison type "fine"	●	●	
Original profile and key cutting comparison type "std"	●	●	
Original profile and key cutting comparison type "by user"	●	●	
Data exchange with Idea in Stand-Alone mode	●	●	●
Data exchange with Unocode 399 Plus via PC		●	
Ignore key cutting length function	●	●	●
Save customised profiles	●	●	●
Search lock manufacturer	●	●	●
Filter for reference market		●	
Direct comparison between two profiles		●	
Special search function for bent keys		●	
Key cutting reading and card search		●	
Full data base	●	●	
Management of references in stock	●	●	
Management of stock hooks	●	●	●
Recurring software updates	●	●	●
Unblocking: from Optika Light to Optika			●
Key Reader Program DVD included	●	●	
Regional database			●
Weight	kg 9	kg 9	kg 9



# MARKER 2000

ENGRAVING DEVICE



- Engraves metal and aluminium items
- Long-lasting marking
- Can be used with Silca Marker Program
- Wide range of optional accessories including clamp for 3 keys and lock
- Weight kg 20

## KEY TYPES

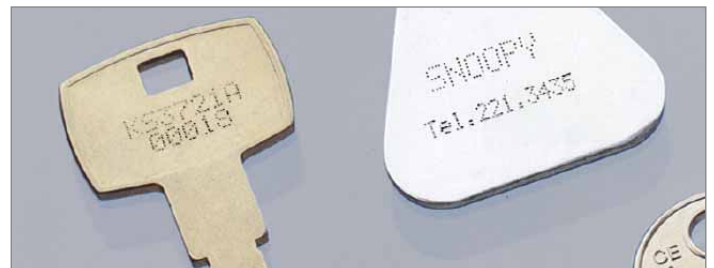
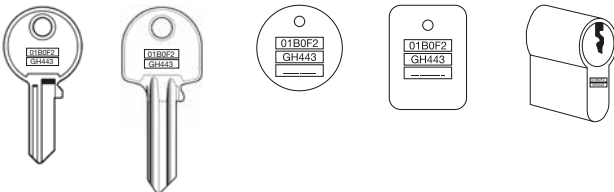

Marker punch

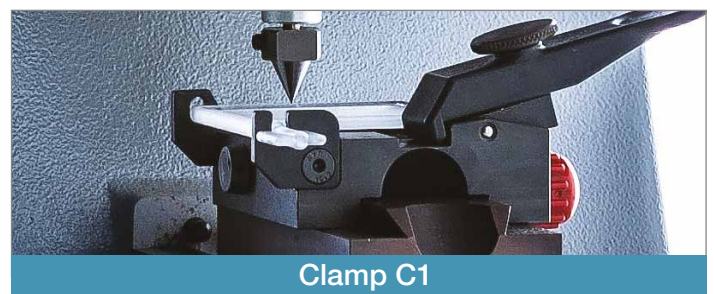

Clamp C1



# MARKER 2000

ENGRAVING DEVICE

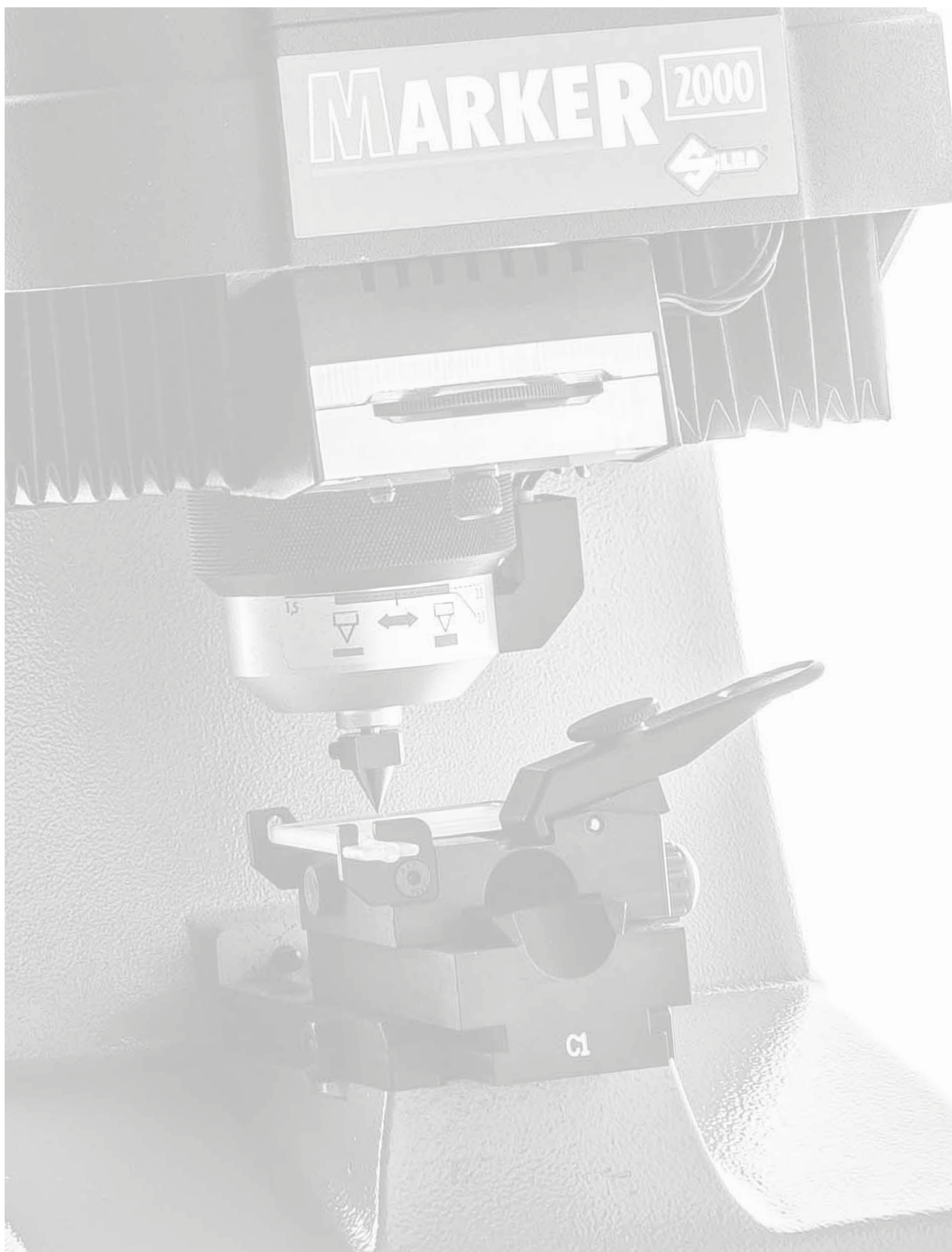



In compliance with current regulations relating to industrial property, we hereby state that the trade-marks or trade names mentioned in this document are the exclusive property of authorized manufacturers of locks and users.

Said trade-marks or trade names are nominated only for the purposes of information so that any lock for which our keys are made can be rapidly identified. This document is reserved exclusively for professional key cutters who use Silca products.

All information and illustrations in this document are for guidance only. Silca reserves the right to alter products designs, dimensions or info to improve the products quality.

The contents of this document are fully protected by Copyright and may not be copied or reproduced in any form, without written permission from Silca S.p.A. Any controversy shall be settled by the Courts of Justice where the company Silca S.p.A. has its headquarters, with express exclusion of any other court.





**POZP-4**  
Printed in Italy 10/2019



**ITALY  
AND OTHER COUNTRIES**  
**SILCA S.p.A.**  
Via Podgora, 20 (Z.I.)  
31029 VITTORIO VENETO (TV)  
Tel. +39 0438 9136  
Fax +39 0438 913800  
E-mail: silca@silca.it  
www.silca.biz - www.silca.it

**FRANCE**  
**SILCA S.A.S.**  
12, Rue de Rouen  
Z.I. Limay-Porcheville  
78440 PORCHEVILLE  
Phone: +33 1 30983500  
Fax +33 1 30983501  
E-mail: info@silca.fr  
www.silca.fr

**SPAIN**  
**SILCA KEY SYSTEMS S.A.**  
C/Santander 73A  
08020 BARCELONA  
Phone: +34 93 4981400  
Fax +34 93 2788004  
E-mail: silca@silca.es  
www.silca.es

**GERMANY**  
**SILCA GmbH**  
Siemensstrasse, 33  
42551 VELBERT  
Phone: +49 2051 2710  
Fax +49 2051 271172  
E-mail: info@silca.de  
www.silca.de

**UNITED KINGDOM**  
**SILCA**  
Unit 6 Lloyds Court  
Manor Royal  
RH10 9QU CRAWLEY  
Phone: +44 1293 531134  
Fax +44 1293 531108  
E-mail: sales@silcald.co.uk  
www.silcald.co.uk

**BENELUX**  
**H. CILLEKENS & B.V.**  
Metaalweg, 4  
6045 JB ROERMOND  
Phone: +31 475 325147  
Fax +31 475 323640  
E-mail: info@hcillekens.nl  
www.hcillekens.nl

**UNITED KINGDOM**  
**ADVANCED DIAGNOSTICS Ltd.**  
Eastboro Fields  
Hemdale Business Park  
CV11 6GL NUNEATON  
Phone: +44 2476 347000  
Fax + 44 2476 347100  
E-mail: sales@advanced-diagnostics.com  
www.advanced-diagnostics.com



dormakaba Group